

The European Union

EDICT OF GOVERNMENT

In order to promote public education and public safety, equal justice for all, a better informed citizenry, the rule of law, world trade and world peace, this legal document is hereby made available on a noncommercial basis, as it is the right of all humans to know and speak the laws that govern them.

EN 1996-1-1 (2005) (English): Eurocode 6: Design of masonry structures - Part 1-1: General rules for reinforced and unreinforced masonry structures [Authority: The European Union Per Regulation 305/2011, Directive 98/34/EC, Directive 2004/18/EC]



BLANK PAGE



English Version

Eurocode 6 - Design of masonry structures - Part 1-1: General rules for reinforced and unreinforced masonry structures

Eurocode 6 - Calcul des ouvrages en maçonnerie - Partie 1-1: Règles communes pour ouvrages en maçonnerie armée et non armée

Eurocode 6 - Bemessung und Konstruktion von Mauerwerksbauten - Teil 1-1: Allgemeine Regeln für bewehrtes und unbewehrtes Mauerwerk

This European Standard was approved by CEN on 23 June 2005.

CEN members are bound to comply with the CEN/CENELEC Internal Regulations which stipulate the conditions for giving this European Standard the status of a national standard without any alteration. Up-to-date lists and bibliographical references concerning such national standards may be obtained on application to the Central Secretariat or to any CEN member.

This European Standard exists in three official versions (English, French, German). A version in any other language made by translation under the responsibility of a CEN member into its own language and notified to the Central Secretariat has the same status as the official versions.

CEN members are the national standards bodies of Austria, Belgium, Cyprus, Czech Republic, Denmark, Estonia, Finland, France, Germany, Greece, Hungary, Iceland, Ireland, Italy, Latvia, Lithuania, Luxembourg, Malta, Netherlands, Norway, Poland, Portugal, Slovakia, Slovenia, Spain, Sweden, Switzerland and United Kingdom.



EUROPEAN COMMITTEE FOR STANDARDIZATION
COMITÉ EUROPÉEN DE NORMALISATION
EUROPÄISCHES KOMITEE FÜR NORMUNG

Management Centre: rue de Stassart, 36 B-1050 Brussels

Contents	Page
Background to the Eurocode programme	7
Status and field of application of Eurocodes	8
National Standards implementing Eurocodes	9
Links between Eurocodes and harmonised technical specifications (ENs and ETAs) for products	9
National Annex for EN 1996-1-1	10
1 General	11
1.1 Scope	11
1.1.1 Scope of Eurocode 6	11
1.1.2 Scope of Part 1-1 of Eurocode 6	11
1.2 Normative references	13
1.2.1 General	13
1.2.2 Reference standards	13
1.3 Assumptions	14
1.4 Distinction between principles and application rules	14
1.5 Terms and Definitions	15
1.5.1 General	15
1.5.2 Terms relating to masonry	15
1.5.3 Terms relating to strength of masonry	15
1.5.4 Terms relating to masonry units	16
1.5.5 Terms relating to mortar	17
1.5.6 Terms relating to concrete infill	18
1.5.7 Terms relating to reinforcement	18
1.5.8 Terms relating to ancillary components	18
1.5.9 Terms relating to mortar joints	19
1.5.10 Terms relating to wall types	19
1.5.11 Miscellaneous terms	20
1.6 Symbols	21
2 Basis of design	27
2.1 Basic requirements	27
2.1.1 General	27
2.1.2 Reliability	27
2.1.3 Design working life and durability	27
2.2 Principles of limit state design	27
2.3 Basic variables	28
2.3.1 Actions	28
2.3.2 Design values of actions	28
2.3.3 Material and product properties	28
2.4 Verification by the partial factor method	28
2.4.1 Design values of material properties	28

2.4.2	Combination of actions	28
2.4.3	Ultimate limit states	28
2.4.4	Serviceability limit states	29
2.5	Design assisted by testing.....	29
3	Materials	30
3.1	Masonry Units	30
3.1.1	Types and grouping of masonry units	30
3.1.2	Properties of masonry units –compressive strength	32
3.2	Mortar	32
3.2.1	Types of masonry mortar	32
3.2.2	Specification of masonry mortar	32
3.2.3	Properties of mortar.....	33
3.3	Concrete infill	33
3.3.1	General	33
3.3.2	Specification for concrete infill	33
3.3.3	Properties of concrete infill	33
3.4	Reinforcing steel	34
3.4.1	General	34
3.4.2	Properties of reinforcing steel bars.....	34
3.4.3	Properties of bed joint reinforcement	34
3.5	Prestressing steel	35
3.6	Mechanical properties of masonry	35
3.6.1	Characteristic compressive strength of masonry	35
3.6.2	Characteristic shear strength of masonry.....	38
3.6.3	Characteristic flexural strength of masonry.....	40
3.6.4	Characteristic anchorage strength of reinforcement.....	42
3.7	Deformation properties of masonry	43
3.7.1	Stress-strain relationship	43
3.7.2	Modulus of elasticity	44
3.7.3	Shear modulus	44
3.7.4	Creep, moisture expansion or shrinkage and thermal expansion	45
3.8	Ancillary components	45
3.8.1	Damp proof courses	45
3.8.2	Wall ties.....	45
3.8.3	Straps, hangers and brackets	46
3.8.4	Prefabricated lintels	46
3.8.5	Prestressing devices.....	46
4	Durability	46
4.1	General	46
4.2	Classification of environmental conditions	46
4.3	Durability of masonry	46
4.3.1	Masonry units	46
4.3.2	Mortar	46
4.3.3	Reinforcing steel	46
4.3.4	Prestressing steel	48
4.3.5	Prestressing devices.....	49
4.3.6	Ancillary components and support angles.....	49
4.4	Masonry below ground	49

5	Structural analysis	49
5.1	General	49
5.2	Structural behaviour in accidental situations (other than earthquakes and fire)	50
5.3	Imperfections	50
5.4	Second order effects	51
5.5	Analysis of structural members	51
5.5.1	Masonry walls subjected to vertical loading	51
5.5.2	Reinforced masonry members subjected to vertical loading	57
5.5.3	Masonry shear walls subjected to shear loading	60
5.5.4	Reinforced masonry members subjected to shear loading	62
5.5.5	Masonry walls subjected to lateral loading	62
6	Ultimate Limit State	64
6.1	Unreinforced masonry walls subjected to mainly vertical loading	64
6.1.1	General	64
6.1.2	Verification of unreinforced masonry walls subjected to mainly vertical loading	64
6.1.3	Walls subjected to concentrated loads	67
6.2	Unreinforced masonry walls subjected to shear loading	70
6.3	Unreinforced masonry walls subjected to lateral loading	70
6.3.1	General	70
6.3.2	Walls arching between supports	72
6.3.3	Walls subjected to wind loading	73
6.3.4	Walls subjected to lateral loading from earth and water	73
6.3.5	Walls subjected to lateral loading from accidental situations	73
6.4	Unreinforced masonry walls subjected to combined vertical and lateral loading	74
6.4.1	General	74
6.4.2	Method using ϕ factor	74
6.4.3	Method using apparent flexural strength	74
6.4.4	Method using equivalent bending coefficients	74
6.5	Ties	74
6.6	Reinforced masonry members subjected to bending, bending and axial loading, or axial loading	75
6.6.1	General	75
6.6.2	Verification of reinforced masonry members subjected to bending and/or axial loading	76
6.6.3	Flanged Reinforced Members	78
6.6.4	Deep beams	80
6.6.5	Composite lintels	82
6.7	Reinforced masonry members subjected to shear loading	82
6.7.1	General	82
6.7.2	Verification of reinforced masonry walls subjected to horizontal loads in the plane of the wall	83
6.7.3	Verification of reinforced masonry beams subjected to shear loading	84
6.7.4	Verification of deep beams subjected to shear loading	85
6.8	Prestressed masonry	85
6.8.1	General	85
6.8.2	Verification of Members	86
6.9	Confined masonry	87
6.9.1	General	87
6.9.2	Verification of members	87

7	Serviceability Limit State	87
7.1	General	87
7.2	Unreinforced masonry walls	88
7.3	Reinforced masonry members	88
7.4	Prestressed masonry members.....	88
7.5	Confined masonry members	89
7.6	Walls subjected to concentrated loads	89
8	Detailing	89
8.1	Masonry details	89
8.1.1	Masonry materials.....	89
8.1.2	Minimum thickness of wall.....	89
8.1.3	Minimum area of wall.....	90
8.1.4	Bonding of masonry	90
8.1.5	Mortar joints.....	91
8.1.6	Bearings under concentrated loads	91
8.2	Reinforcement details	91
8.2.1	General.....	91
8.2.2	Cover to reinforcing steel	92
8.2.3	Minimum area of reinforcement.....	92
8.2.4	Size of reinforcing steel.....	93
8.2.5	Anchorage and laps.....	93
8.2.6	Restraint of compression reinforcing steel.....	97
8.2.7	Spacing of reinforcing steel	97
8.3	Prestressing details.....	98
8.4	Confined masonry details	98
8.5	Connection of walls	98
8.5.1	Connection of walls to floors and roofs.....	98
8.5.2	Connection between walls.....	99
8.6	Chases and recesses on walls	100
8.6.1	General.....	100
8.6.2	Vertical chases and recesses	101
8.6.3	Horizontal and inclined chases.....	101
8.7	Damp proof courses	102
8.8	Thermal and long term movement	102
9	Execution.....	102
9.1	General.....	102
9.2	Design of structural members	103
9.3	Loading of masonry	103
Annex A (informative) Consideration of partial factors relating to Execution.....		104
Annex B (informative) Method for calculating the eccentricity of a stability core.....		105
Annex C (informative) A simplified method for calculating the out-of-plane eccentricity of loading on walls.....		107
Annex D (informative) Determination of ρ_3 and ρ_4.....		111
Annex E (informative) Bending moment coefficients, α_2, in single leaf laterally loaded wall panels of thickness less than or equal to 250 mm.....		112

Annex F (informative) Limiting height and length to thickness ratios for walls under the serviceability limit state	117
Annex G (informative) Reduction factor for slenderness and eccentricity	119
Annex H (informative) Enhancement factor as given in 6.1.3	121
Annex I (informative) Adjustment of lateral load for walls supported on three or four edges subjected to out-of-plane horizontal loading and vertical loading	122
Annex J (informative) Reinforced masonry members subjected to shear loading: enhancement of f_{vd}	123

Foreword

This document EN 1996-1-1 has been prepared by Technical Committee CEN/TC 250 “Structural Eurocodes”, the secretariat of which is held by BSI.

This European Standard shall be given the status of a national standard, either by publication of an identical text or by endorsement, at the latest by May 2006, and conflicting national standards shall be withdrawn at the latest by March 2010.

CEN/TC 250 is responsible for all Structural Eurocodes.

This document supersedes ENV 1996-1-1:1995 and ENV 1996-1-3:1998.

According to the CEN/CENELEC Internal Regulations, the national standards organizations of the following countries are bound to implement this European Standard: Austria, Belgium, Cyprus, Czech Republic, Denmark, Estonia, Finland, France, Germany, Greece, Hungary, Iceland, Ireland, Italy, Latvia, Lithuania, Luxembourg, Malta, Netherlands, Norway, Poland, Portugal, Slovakia, Slovenia, Spain, Sweden, Switzerland and the United Kingdom.

Background to the Eurocode programme

In 1975, the Commission of the European Community decided on an action programme in the field of construction, based on Article 95 of the Treaty. The objective of the programme was the elimination of technical obstacles to trade and the harmonisation of technical specifications.

Within this action programme, the Commission took the initiative to establish a set of harmonised technical rules for the design of construction works which, in a first stage, would serve as an alternative to the national rules in force in the Member States and, ultimately, would replace them.

For fifteen years, the Commission, with the help of a Steering Committee with Representatives of Member States, conducted the development of the Eurocodes programme, which led to the first generation of European codes in the 1980's.

In 1989, the Commission and the Member States of the EU and EFTA decided, on the basis of an agreement¹⁾ between the Commission and CEN, to transfer the preparation and the publication of the Eurocodes to the CEN through a series of Mandates, in order to provide them with a future status of European Standard (EN). This links de facto the Eurocodes with the provisions of all the Council's Directives and/or Commission's Decisions dealing with European standards (e.g. the Council Directive 89/106/EEC on construction products - CPD - and Council Directives 93/37/EEC, 92/50/EEC and 89/440/EEC on public works and services and equivalent EFTA Directives initiated in pursuit of setting up the internal market).

1) Agreement between the Commission of the European Communities and the European Committee for Standardisation (CEN) concerning the work on EUROCODES for the design of building and civil engineering works (BC/CEN/03/89).

The Structural Eurocode programme comprises the following standards generally consisting of a number of Parts:

EN 1990, *Eurocode: Basis of structural design.*

EN 1991, *Eurocode 1: Actions on structures.*

EN 1992, *Eurocode 2: Design of concrete structures.*

EN 1993, *Eurocode 3: Design of steel structures.*

EN 1994, *Eurocode 4: Design of composite steel and concrete structures.*

EN 1995, *Eurocode 5: Design of timber structures.*

EN 1996, *Eurocode 6: Design of masonry structures.*

EN 1997, *Eurocode 7: Geotechnical design.*

EN 1998, *Eurocode 8: Design of structures for earthquake resistance.*

EN 1999, *Eurocode 9: Design of aluminium structures.*

Eurocode standards recognise the responsibility of regulatory authorities in each Member State and have safeguarded their right to determine values related to regulatory safety matters at national level where these continue to vary from State to State.

Status and field of application of Eurocodes

The Member States of the EU and EFTA recognise that Eurocodes serve as reference documents for the following purposes:

- as a means to prove compliance of building and civil engineering works with the essential requirements of Council Directive 89/106/EEC, particularly Essential Requirement N°1 — Mechanical resistance and stability — and Essential Requirement N°2 — Safety in case of fire;
- as a basis for specifying contracts for construction works and related engineering services;
- as a framework for drawing up harmonised technical specifications for construction products (ENs and ETAs).

The Eurocodes, as far as they concern the construction works themselves, have a direct relationship with the Interpretative Documents²⁾ referred to in Article 12 of the CPD, although they are of a different nature from harmonised product standards³⁾. Therefore, technical aspects arising from the

2) According to Article 3.3 of the CPD, the essential requirements (ERs) shall be given concrete form in interpretative documents for the creation of the necessary links between the essential requirements and the mandates for harmonised ENs and ETAGs/ETAs.

3) According to Article 12 of the CPD the interpretative documents shall :

- a) give concrete form to the essential requirements by harmonising the terminology and the technical bases and indicating classes or levels for each requirement where necessary ;
- b) indicate methods of correlating these classes or levels of requirement with the technical specifications, e. g. methods of calculation

Eurocodes work need to be adequately considered by CEN Technical Committees and/or EOTA Working Groups working on product standards with a view to achieving full compatibility of these technical specifications with the Eurocodes.

The Eurocode standards provide common structural design rules for everyday use for the design of whole structures and component products of both a traditional and an innovative nature. Unusual forms of construction or design conditions are not specifically covered and additional expert consideration will be required by the designer in such cases.

National Standards implementing Eurocodes

The National Standards implementing Eurocodes will comprise the full text of the Eurocode (including any annexes), as published by CEN, which may be preceded by a National title page and National foreword, and may be followed by a National Annex (informative).

The National Annex may only contain information on those parameters which are left open in the Eurocode for national choice, known as Nationally Determined Parameters, to be used for the design of buildings and civil engineering works to be constructed in the country concerned, i. e.:

- values and/or classes where alternatives are given in the Eurocode,
- values to be used where a symbol only is given in the Eurocode,
- country specific data (geographical, climatic etc), e.g. snow map,
- the procedure to be used where alternative procedures are given in the Eurocode

and it may also contain:

- decisions on the application of informative annexes,
- references to non-contradictory complementary information to assist the user to apply the Eurocode.

Links between Eurocodes and harmonised technical specifications (ENs and ETAs) for products

There is a need for consistency between the harmonised technical specifications for construction products and the technical rules for works⁴⁾. Furthermore, all the information accompanying the CE Marking of the construction products, which refer to Eurocodes, shall clearly mention which Nationally Determined Parameters have been taken into account.

This European Standard is Part of EN 1996 which comprises the following Parts:

and of proof, technical rules for project design, etc. ;

c) serve as a reference for the establishment of harmonised standards and guidelines for European technical approvals. The Eurocodes, *de facto*, play a similar role in the field of the ER 1 and a part of ER 2.

4) see Article 3.3 and Article 12 of the CPD, as well as clauses 4.2, 4.3.1, 4.3.2 and 5.2 of ID 1.

Part 1-1: General - *Rules for reinforced and unreinforced masonry structures*

NOTE This Part combines ENV 1996-1-1 and ENV 1996-1-3.

Part 1-2: General rules - *Structural fire design*.

Part 2: *Design considerations, selection of materials and execution of masonry*.

Part 3: *Simplified calculation methods for unreinforced masonry structures*

EN 1996-1-1 describes the Principles and requirements for safety, serviceability and durability of masonry structures. It is based on the limit state concept used in conjunction with a partial factor method.

For the design of new structures, EN 1996-1-1 is intended to be used, for direct application, together with ENs 1990, 1991, 1992, 1993, 1994, 1995, 1997, 1998 and 1999.

EN 1996-1-1 is intended for use by:

- committees drafting standards for structural design and related products, testing and execution standards;
- clients (e. g. for the formulation of their specific requirements on reliability levels and durability);
- designers and contractors;
- relevant authorities.

National Annex for EN 1996-1-1

This standard gives some symbols and some alternative methods for which a National value or choice needs to be given; notes under the relevant clauses indicate where national choices may have to be made. The National Standard implementing EN 1996-1-1 in a particular country should have a National Annex containing all Nationally Determined Parameters to be used for the design of buildings and civil engineering works to be constructed in that country.

National choice is allowed in EN 1996-1-1 through clauses:

- 2.4.3(1)P Ultimate limit states;
- 2.4.4(1) Serviceability limit states;
- 3.2.2(1) Specification of masonry mortar;
- 3.6.1.2(1) Characteristic compressive strength of masonry other than shell bedded;
- 3.6.2(3), (4) and (6) Characteristic shear strength of masonry;
- 3.6.3(3) Characteristic flexural strength of masonry;

- 3.7.2(2) Modulus of elasticity;
- 3.7.4(2) Creep, moisture expansion or shrinkage and thermal expansion;
- 4.3.3(3) and (4) Reinforcing steel;
- 5.5.1.3(3) Effective thickness of masonry walls;
- 6.1.2.2(2) Slenderness ratio λ_c below which creep may be ignored;
- 8.1.2 (2) Minimum thickness of wall;
- 8.5.2.2(2) Cavity and veneer walls;
- 8.5.2.3(2) Double-leaf walls.
- 8.6.2 (1) Vertical chases and recesses;
- 8.6.3 (1) Horizontal and inclined chases

Section 1 General

1.1 Scope

1.1.1 Scope of Eurocode 6

(1)P Eurocode 6 applies to the design of buildings and civil engineering works, or parts thereof, in unreinforced, reinforced, prestressed and confined masonry.

(2)P Eurocode 6 deals only with the requirements for resistance, serviceability and durability of structures. Other requirements, for example, concerning thermal or sound insulation, are not considered.

(3)P Execution is covered to the extent that is necessary to indicate the quality of the construction materials and products that should be used and the standard of workmanship on site needed to comply with the assumptions made in the design rules.

(4)P Eurocode 6 does not cover the special requirements of seismic design. Provisions related to such requirements are given in Eurocode 8 which complements, and is consistent with Eurocode 6.

(5)P Numerical values of the actions on buildings and civil engineering works to be taken into account in the design are not given in Eurocode 6. They are provided in Eurocode 1.

1.1.2 Scope of Part 1-1 of Eurocode 6

(1)P The basis for the design of buildings and civil engineering works in masonry is given in this Part 1-1 of Eurocode 6, which deals with unreinforced masonry and reinforced masonry where the reinforcement is added to provide ductility, strength or improve serviceability. The principles of the design of prestressed masonry and confined masonry are given, but application rules are not provided. This Part is not valid for masonry with a plan area of less than 0,04 m².

(2) For those types of structures not covered entirely, for new structural uses for established materials, for new materials, or where actions and other influences outside normal experience have to be resisted, the principles and application rules given in this EN may be applicable, but may need to be supplemented.

(3) Part 1-1 gives detailed rules which are mainly applicable to ordinary buildings. The applicability of these rules may be limited, for practical reasons or due to simplifications; any limits of applicability are given in the text where necessary.

(4)P The following subjects are dealt with in Part 1-1:

- section 1 : General;
- section 2 : Basis of design;
- section 3 : Materials;
- section 4 : Durability;
- section 5 : Structural analysis;
- section 6 : Ultimate Limit State;
- section 7 : Serviceability Limit State;
- section 8 : Detailing;
- section 9 : Execution;

(5)P Part 1-1 does not cover:

- resistance to fire (which is dealt with in EN 1996-1-2);
- particular aspects of special types of building (for example, dynamic effects on tall buildings);
- particular aspects of special types of civil engineering works (such as masonry bridges, dams, chimneys or liquid-retaining structures);
- particular aspects of special types of structures (such as arches or domes);
- masonry where gypsum, with or without cement, mortars are used;
- masonry where the units are not laid in a regular pattern of courses (rubble masonry);
- masonry reinforced with other materials than steel.

AC1 *Subclause deleted* AC1

1.2 Normative references

1.2.1 General

(1)P This European standard incorporates by dated or undated reference, provisions from other publications. These normative references are cited at the appropriate places in the text and the publications are listed hereafter. For dated references, subsequent amendments to, or revisions of, any of these publications apply to this European standard only when incorporated in it by amendment or revision. For undated references the latest edition of the publication referred to applies (including amendments).

1.2.2 Reference standards

The following standards are referenced in this EN 1996-1-1:

- EN 206-1, *Concrete — Part 1: Specification, performance, production and conformity*;
- EN 771-1, *Specification for masonry units — Part 1: Clay masonry units*;
- EN 771-2, *Specification for masonry units — Part 2: Calcium silicate masonry units*;
- EN 771-3, *Specification for masonry units — Part 3: Aggregate concrete masonry units (Dense and light-weight aggregates)*;
- EN 771-4, *Specification for masonry units — Part 4: Autoclaved aerated concrete masonry units*;
- EN 771-5, *Specification for masonry units — Part 5: Manufactured stone masonry units*;
- EN 771-6, *Specification for masonry units — Part 6: Natural stone masonry units*;
- EN 772-1, *Methods of test for masonry units — Part 1: Determination of compressive strength*;
- EN 845-1, *Specification for ancillary components for masonry — Part 1: Ties, tension straps, hangers and brackets*;
- EN 845-2, *Specification for ancillary components for masonry — Part 2: Lintels*;
- EN 845-3, *Specification for ancillary components for masonry — Part 3: Bed joint reinforcement of steel meshwork*;
- EN 846-2, *Methods of test for ancillary components for masonry — Part 2: Determination of bond strength of prefabricated bed joint reinforcement in mortar joints*;
- EN 998-1, *Specification for mortar for masonry — Part 1: Rendering and plastering mortar*;
- EN 998-2, *Specification for mortar for masonry — Part 2: Masonry mortar*;

- EN 1015-11, *Methods of test for mortar for masonry — Part 11: Determination of flexural and compressive strength of hardened mortar*;
- EN 1052-1, *Methods of test for masonry — Part 1: Determination of compressive strength*;
- EN 1052-2, *Methods of test for masonry — Part 2: Determination of flexural strength*;
- EN 1052-3, *Methods of test for masonry — Part 3: Determination of initial shear strength*;
- EN 1052-4, *Methods of test for masonry — Part 4: Determination of shear strength including damp proof course*;
- EN 1052-5, *Methods of test for masonry — Part 5: Determination of bond strength by bond wrench method*;
- EN 1990, *Basis of structural design*;
- EN 1991, *Actions on structures*;
- EN 1992, *Design of concrete structures*;
- EN 1993, *Design of steel structures*;
- EN 1994, *Design of composite steel and concrete structures*;
- EN 1995, *Design of timber structures*;
- EN 1996-2, *Design, selection of materials and execution of masonry*;
- EN 1997, *Geotechnical design*;
- EN 1999, *Design of aluminium structures*;
- EN 10080, *Steel for the reinforcement of concrete - Weldable reinforcing steel*;
- prEN 10138, *Prestressing steels*;

AC1 — prEN 10348, *Steel for the reinforcement of concrete — Galvanized reinforcing steel*. AC1

1.3 Assumptions

(1)P The assumptions given in 1.3 of EN 1990:2002 apply to this EN 1996-1-1.

1.4 Distinction between principles and application rules

(1)P The rules in 1.4 of EN 1990:2002 apply to this EN 1996-1-1.

1.5 Terms and Definitions

1.5.1 General

(1) The terms and definitions given in EN 1990:2002, Clause 1.5, apply to this EN 1996-1-1.

(2) The terms and definitions used in this EN 1996-1-1 are given the meanings contained in clauses 1.5.2 to 1.5.11, inclusive.

1.5.2 Terms relating to masonry

1.5.2.1

masonry

an assemblage of masonry units laid in a specified pattern and joined together with mortar

1.5.2.2

unreinforced masonry

masonry not containing sufficient reinforcement so as to be considered as reinforced masonry

1.5.2.3

reinforced masonry

masonry in which bars or mesh are embedded in mortar or concrete so that all the materials act together in resisting action effects

1.5.2.4

prestressed masonry

masonry in which internal compressive stresses have been intentionally induced by tensioned reinforcement

1.5.2.5

confined masonry

masonry provided with reinforced concrete or reinforced masonry confining elements in the vertical and horizontal direction

1.5.2.6

masonry bond

disposition of units in masonry in a regular pattern to achieve common action

1.5.3 Terms relating to strength of masonry

1.5.3.1

characteristic strength of masonry

value of the strength of masonry having a prescribed probability of 5% of not being attained in a hypothetically unlimited test series. This value generally corresponds to a specified fractile of the assumed statistical distribution of the particular property of the material or product in a test series. A nominal value is used as the characteristic value in some circumstances

1.5.3.2

compressive strength of masonry

the strength of masonry in compression without the effects of platen restraint, slenderness or eccentricity of loading

1.5.3.3

shear strength of masonry

\square_{AC1} the strength of masonry in shear subjected to shear forces \square_{AC1}

1.5.3.4

flexural strength of masonry

the strength of masonry in bending

1.5.3.5

anchorage bond strength

the bond strength, per unit surface area, between reinforcement and concrete or mortar, when the reinforcement is subjected to tensile or compressive forces

1.5.3.6

adhesion

the effect of mortar developing a tensile and shear resistance at the contact surface of masonry units

1.5.4 Terms relating to masonry units

1.5.4.1

masonry unit

a preformed component, intended for use in masonry construction

1.5.4.2

groups 1, 2, 3 and 4 masonry units

group designations for masonry units, according to the percentage size and orientation of holes in the units when laid

1.5.4.3

bed face

the top or bottom surface of a masonry unit when laid as intended

1.5.4.4

frog

a depression, formed during manufacture, in one or both bed faces of a masonry unit

1.5.4.5

hole

a formed void which may or may not pass completely through a masonry unit

1.5.4.6

griphole

a formed void in a masonry unit to enable it to be more readily grasped and lifted with one or both hands or by machine

1.5.4.7

web

the solid material between the holes in a masonry unit

1.5.4.8**shell**

the peripheral material between a hole and the face of a masonry unit

1.5.4.9**gross area**

the area of a cross-section through the unit without reduction for the area of holes, voids and re-entrants

1.5.4.10**compressive strength of masonry units**

the mean compressive strength of a specified number of masonry units (see EN 771-1 to EN 771-6)

1.5.4.11**normalized compressive strength of masonry units**

the compressive strength of masonry units converted to the air dried compressive strength of an equivalent 100 mm wide x 100 mm high masonry unit (see EN 771-1 to EN 771-6)

1.5.5 Terms relating to mortar**1.5.5.1****masonry mortar**

mixture of one or more inorganic binders, aggregates and water, and sometimes additions and/or admixtures, for bedding, jointing and pointing of masonry

1.5.5.2**general purpose masonry mortar**

masonry mortar without special characteristics

1.5.5.3**thin layer masonry mortar**

designed masonry mortar with a maximum aggregate size less than or equal to a prescribed figure

NOTE see note in 3.6.1.2 (2)

1.5.5.4**lightweight masonry mortar**

AC1 designed masonry mortar with a dry hardened density equal to or below 1300 kg/m³ according to EN 998-2 **AC1**

1.5.5.5**designed masonry mortar**

a mortar whose composition and manufacturing method is chosen in order to achieve specified properties (performance concept)

1.5.5.6**prescribed masonry mortar**

mortar made in predetermined proportions, the properties of which are assumed from the stated proportions of the constituents (recipe concept)

1.5.5.7**factory made masonry mortar**

mortar batched and mixed in a factory

1.5.5.8

semi-finished factory made masonry mortar

prebatched masonry mortar or a premixed lime and sand masonry mortar

1.5.5.9

prebatched masonry mortar

mortar whose constituents are wholly batched in a factory, supplied to the building site and mixed there according to the manufacturers' specification and conditions

1.5.5.10

premixed lime and sand masonry mortar

mortar whose constituents are wholly batched and mixed in a factory, supplied to the building site, where further constituents specified or provided by the factory are added (e. g. cement) and mixed with the lime and sand

1.5.5.11

site-made mortar

a mortar composed of individual constituents batched and mixed on the building site

1.5.5.12

compressive strength of mortar

the mean compressive strength of a specified number of mortar specimens after curing for 28 days

1.5.6 Terms relating to concrete infill

1.5.6.1

concrete infill

a concrete used to fill pre-formed cavities or voids in masonry

1.5.7 Terms relating to reinforcement

1.5.7.1

reinforcing steel

steel reinforcement for use in masonry

1.5.7.2

bed joint reinforcement

reinforcing steel that is prefabricated for building into a bed joint

1.5.7.3

prestressing steel

steel wires, bars or strands for use in masonry

1.5.8 Terms relating to ancillary components

1.5.8.1

damp proof course

a layer of sheeting, masonry units or other material used in masonry to resist the passage of water

1.5.8.2

wall tie

a device for connecting one leaf of a cavity wall across a cavity to another leaf or to a framed structure or backing wall

1.5.8.3

strap

a device for connecting masonry members to other adjacent components, such as floors and roofs

1.5.9 Terms relating to mortar joints

1.5.9.1

bed joint

a mortar layer between the bed faces of masonry units

1.5.9.2

perpend joint (head joint)

a mortar joint perpendicular to the bed joint and to the face of wall

1.5.9.3

longitudinal joint

a vertical mortar joint within the thickness of a wall, parallel to the face of the wall

1.5.9.4

thin layer joint

a joint made with thin layer mortar

1.5.9.5

jointing

the process of finishing a mortar joint as the work proceeds

1.5.9.6

pointing

the process of filling and finishing mortar joints where the surface of the joint has been raked out or left open for pointing

1.5.10 Terms relating to wall types

1.5.10.1

load-bearing wall

a wall primarily designed to carry an imposed load in addition to its own weight

1.5.10.2

single-leaf wall

a wall without a cavity or continuous vertical joint in its plane

1.5.10.3

cavity wall

a wall consisting of two parallel single-leaf walls, effectively tied together with wall ties or bed joint reinforcement. The space between the leaves is left as a continuous cavity or filled or partially filled with non-loadbearing thermal insulating material

NOTE A wall consisting of two leaves separated by a cavity, where one of the leaves is not contributing to the strength or stiffness of the other (possibly loadbearing) leaf, is to be regarded as a veneer wall.

1.5.10.4

double-leaf wall

a wall consisting of two parallel leaves with the longitudinal joint between filled solidly with mortar and securely tied together with wall ties so as to result in common action under load

1.5.10.5

grouted cavity wall

a wall consisting of two parallel leaves with the cavity filled with concrete or grout and securely tied together with wall ties or bed joint reinforcement so as to result in common action under load

1.5.10.6

faced wall

a wall with facing units bonded to backing units so as to result in common action under load

1.5.10.7

shell bedded wall

a wall in which the masonry units are bedded on two or more strips of mortar two of which are at the outside edges of the bed face of the units

1.5.10.8

veneer wall

a wall used as a facing but not bonded or contributing to the strength of the backing wall or framed structure

1.5.10.9

shear wall

a wall to resist lateral forces in its plane

1.5.10.10

stiffening wall

a wall set perpendicular to another wall to give it support against lateral forces or to resist buckling and so to provide stability to the building

1.5.10.11

non-loadbearing wall

a wall not considered to resist forces such that it can be removed without prejudicing the remaining integrity of the structure

1.5.11 Miscellaneous terms

1.5.11.1

chase

channel formed in masonry

1.5.11.2

recess

indentation formed in the face of a wall

1.5.11.3**grout**

a pourable mixture of cement, sand and water for filling small voids or spaces

1.5.11.4**movement joint**

a joint permitting free movement in the plane of the wall

1.6 Symbols

(1) Material-independent symbols are given in 1.6 of EN 1990.

(2) Material-dependent symbols used in this EN 1996-1-1 are:

Latin letters

a_1	distance from the end of a wall to the nearest edge of a loaded area;
a_x	distance from the face of a support to the cross-section being considered;
A	loaded horizontal gross cross-sectional area of a wall;
A_{ef}	effective area of bearing;
A_s	cross-sectional area of steel reinforcement;
A_{sw}	area of shear reinforcement;
b	width of a section;
b_c	width of the compression face midway between restraints;
b_{ef}	effective width of a flanged member;
$\overline{AC1} b_{ef,l}$	effective width of a L-shaped flanged member;
$b_{ef,t}$	effective width of a T-shaped flanged member; $\overline{AC1}$
c_{nom}	nominal concrete cover;
d	effective depth of a beam;
d_a	deflection of an arch under the design lateral load;
d_c	largest dimension of the cross section of a core in the direction of bending;
e_c	additional eccentricity;
e_{hc}	eccentricity at the top or bottom of a wall, resulting from horizontal loads;

e_{hm}	eccentricity at the middle of a wall, resulting from horizontal loads;
e_i	eccentricity at the top or the bottom of a wall;
e_{init}	initial eccentricity;
e_k	eccentricity due to creep;
e_m	eccentricity due to loads;
e_{mk}	eccentricity at the middle of the wall;
E	short term secant modulus of elasticity of masonry;
$\boxed{AC1}E_d$	design value of the load applied to a reinforced masonry member; $\boxed{AC1}$
$E_{longterm}$	long term modulus of elasticity of masonry;
E_n	modulus of elasticity of member n;
f_b	normalised mean compressive strength of a masonry unit;
f_{bod}	design anchorage strength of reinforcing steel;
f_{bok}	characteristic anchorage strength;
f_{ck}	characteristic compressive strength of concrete infill;
f_{cvk}	characteristic shear strength of concrete infill;
f_d	design compressive strength of masonry in the direction being considered;
f_k	characteristic compressive strength of masonry;
f_m	compressive strength of masonry mortar;
f_{vd}	design shear strength of masonry;
f_{vk}	characteristic shear strength of masonry;
f_{vko}	characteristic initial shear strength of masonry, under zero compressive stress;
f_{vlt}	limit to the value of f_{vk} ;
f_{xd}	design flexural strength appropriate to the plane of bending;
f_{xd1}	design flexural strength of masonry having the plane of failure parallel to the bed joints;
$f_{xd1,app}$	apparent design flexural strength of masonry having the plane of failure parallel to the bed joints;

f_{xk1}	characteristic flexural strength of masonry having $\langle AC_1 \rangle$ the plane of failure $\langle AC_1 \rangle$ parallel to the bed joints;
f_{xd2}	design flexural strength of masonry having the plane of failure perpendicular to the bed joints;
$f_{xd2,app}$	apparent design flexural strength of masonry having the plane of failure perpendicular to the bed joints;
f_{xk2}	characteristic flexural strength of masonry having $\langle AC_1 \rangle$ the plane of failure $\langle AC_1 \rangle$ perpendicular to the bed joints;
f_{yd}	design strength of reinforcing steel;
f_{yk}	characteristic strength of reinforcing steel
F_d	design compressive or tensile resistance of a wall tie;
g	total of the widths of mortar strips;
G	shear modulus of masonry;
h	clear height of a masonry wall;
h_i	clear height of masonry wall, i ;
h_{cf}	effective height of a wall;
h_{tot}	total height of a structure, from the top of the foundation, or a wall, or a core;
h_c	height of a wall to the level of the load;
I_j	second moment of area of member, j ;
k	ratio of the lateral load capacity of a vertically spanning wall to the lateral load capacity of the actual wall area, taking possible edge restraint into account;
k_m	ratio of slab stiffness to wall stiffness
k_r	rotational stiffness of a restraint;
K	constant used in the calculation of the compressive strength of masonry;
l	length of a wall (between other walls, between a wall and an opening, or between openings);
l_b	straight anchorage length;
l_c	length of the compressed part of a wall;

l_{cl}	clear length of an opening
l_{ef}	effective span of a masonry beam;
l_{efm}	effective length of a bearing at mid height of a wall;
l_r	clear distance between lateral restraints;
l_a	the length or the height of the wall between supports capable of resisting an arch thrust;
M_{ad}	additional design moment;
M_d	design bending moment at the bottom of a core;
$\boxed{AC1}$ M_i	end moment at node i ; $\boxed{AC1}$
M_{id}	design value of the bending moment at the top or the bottom of the wall;
M_{md}	design value of the greatest moment at the middle of the height of the wall;
M_{Rd}	design value of the moment of resistance;
M_{Ed}	design value of the moment applied;
M_{Edu}	design value of the moment above a floor;
M_{Edf}	design value of the moment below a floor;
n	number of storeys;
n_i	stiffness factor of members;
n_t	number of wall ties or connectors per m ² of wall;
n_{tmin}	minimum number of wall ties or connectors per m ² of wall;
N	sum of the design vertical actions on a building;
N_{ad}	the maximum design arch thrust per unit length of wall;
N_{id}	design value of the vertical load at the top or bottom of a wall or column;
N_{md}	design value of the vertical load at the middle of the height of a wall or column;
N_{Rd}	design value of the vertical resistance of a masonry wall or column;
N_{Rdc}	design value of the vertical concentrated load resistance of a wall;

N_{Ed} design value of the vertical load;

N_{Edf} design value of the load out of a floor;

N_{Edu} design value of the load above the floor;

AC1 *Text deleted* **AC1**

N_{Edc} design value of a concentrated vertical load;

$q_{lat,d}$ design lateral strength per unit area of wall;

Q_d design value of the total vertical load, in the part of a building stabilised by a core;

r arch rise;

AC1 R_c yield strength of steel; **AC1**

s spacing of shear reinforcement;

AC1 *Text deleted* **AC1**

t thickness of a wall;

$t_{ch,v}$ maximum depth of a vertical chase or recess without calculation;

$t_{ch,h}$ maximum depth of a horizontal or inclined chase;

t_i thickness of wall i ;

t_{min} minimum thickness of a wall;

t_{ef} effective thickness of a wall;

t_f thickness of a flange;

t_{ri} thickness of the rib, i ;

V_{Ed} design value of a shear load;

V_{Rd} design value of the shear resistance;

w_i uniformly distributed design load, i ;

W_{Ed} design lateral load per unit area;

x depth to the neutral axis;

z lever arm;

Z elastic section modulus of a unit height or length of the wall;

Greek letters

α angle of shear reinforcement to the axis of the beam;

α_t coefficient of thermal expansion of masonry ;

$\alpha_{1,2}$ bending moment coefficients;

β enhancement factor for concentrated loads;

χ magnification factor for the shear resistance of reinforced walls;

δ factor used in the determination of the normalised mean compressive strength of masonry units;

ε_{∞} final creep strain of masonry;

ε_{el} elastic strain of masonry;

ε_{mu} limiting compressive strain in masonry;

ε_{sy} yield strain of reinforcement;

ϕ effective diameter of the reinforcing steel;

ϕ_{∞} final creep coefficient of masonry;

Φ reduction factor;

Φ_{fl} reduction factor, taking the influence of the flexural strength into account;

Φ_1 reduction factor at the top or bottom of the wall;

Φ_m reduction factor within the middle height of the wall;

γ_M partial factor for materials, including uncertainties about geometry and modelling;

η factor for use in calculating the out-of-plane eccentricity of loading on walls;

λx depth of the compressed zone in a beam, when using a rectangular stress block;

λ_c value of the slenderness ratio up to which eccentricities due to creep can be neglected;

μ orthogonal ratio of the flexural strengths of masonry;

ξ magnification factor for the rotational stiffness of the restraint of the structural element being considered;

ρ_d	dry density;
ρ_n	reduction factor;
ρ_t	stiffness coefficient;
σ_d	design compressive stress ;
ν	angle of inclination to the vertical of the structure.

Section 2 Basis of design

2.1 Basic requirements

2.1.1 General

- (1)P The design of masonry structures shall be in accordance with the general rules given in EN 1990.
- (2)P Specific provisions for masonry structures are given in this section and shall be applied.
- (3) The basic requirements of EN 1990 Section 2 are deemed to be satisfied for masonry structures when the following are applied:
- limit state design in conjunction with the partial factor method described in EN 1990;
 - actions given in EN 1991;
 - combination rules given in EN 1990;
 - the principles and rules of application given in this EN 1996-1-1.

2.1.2 Reliability

- (1)P The reliability required for masonry structures will be obtained by carrying out design according to this EN 1996-1-1.

2.1.3 Design working life and durability

- (1) For the consideration of durability reference should be made to Section 4.

2.2 Principles of limit state design

- (1)P Limit states may concern only the masonry, or such other materials as are used for parts of the structure, for which reference shall be made to relevant Parts of EN 1992, EN 1993, EN 1994, EN 1995 and EN 1999.
- (2)P For masonry structures, the ultimate limit state and serviceability limit state shall be considered for all aspects of the structure including ancillary components in the masonry.

(3)P For masonry structures, all relevant design solutions including relevant stages in the sequence of construction shall be considered.

2.3 Basic variables

2.3.1 Actions

(1)P Actions shall be obtained from the relevant Parts of EN 1991.

2.3.2 Design values of actions

(1)P Partial factors for actions γ_{AC1} shall γ_{AC1} be obtained from EN 1990.

(2) Partial factors for creep and shrinkage of concrete elements in masonry structures should be obtained from EN 1992-1-1.

(3) For serviceability limit states, imposed deformations should be introduced as estimated (mean) values.

2.3.3 Material and product properties

(1) Properties of materials and construction products and geometrical data to be used for design should be those specified in the relevant ENs, hENs or ETAs, unless otherwise indicated in this EN 1996-1-1.

2.4 Verification by the partial factor method

2.4.1 Design values of material properties

(1)P The design value for a material property is obtained by dividing its characteristic value by the relevant partial factor for materials, γ_M .

2.4.2 Combination of actions

(1)P Combination of actions shall be in accordance with the general rules given in EN 1990.

NOTE 1 In residential and office structures, it will usually be possible to simplify the load combinations given in EN 1990.

NOTE 2 In normal residential and office structures the imposed loads, as given in the EN 1991-1 series, may be treated as one fixed variable action (that is, equal loading on all spans, or zero, when appropriate) for which reduction factors are given in the EN 1991-1 series.

2.4.3 Ultimate limit states

(1)P The relevant values of the partial factor for materials γ_M shall be used for the ultimate limit state for ordinary and accidental situations. When analysing the structure for accidental actions, the probability of the accidental action being present shall be taken into account.

NOTE The numerical values to be ascribed to the symbol γ_M for use in a country may be found in its National Annex. Recommended values, given as classes that may be related to execution control (see also Annex A) according to national choice, are given in the table below.

Material		γ_M				
		Class				
		1	2	3	4	5
	Masonry made with:					
A	Units of Category I, designed mortar ^a	1,5	1,7	2,0	2,2	2,5
B	Units of Category I, prescribed mortar ^b	1,7	2,0	2,2	2,5	2,7
C	Units of Category II, any mortar ^{a, b, e}	2,0	2,2	2,5	2,7	3,0
D	Anchorage of reinforcing steel	1,7	2,0	2,2	2,5	2,7
E	Reinforcing steel and prestressing steel	1,15				
F	Ancillary components ^{c, d}	1,7	2,0	2,2	2,5	2,7
G	Lintels according to EN 845-2	1,5 to 2,5				
^a Requirements for designed mortars are given in EN 998-2 and EN 1996-2. ^b Requirements for prescribed mortars are given in EN 998-2 and EN 1996-2. ^c Declared values are mean values. ^d Damp proof courses are assumed to be covered by masonry γ_M . ^e When the coefficient of variation for Category II units is not greater than 25 %.						

END OF NOTE

2.4.4 Serviceability limit states

(1) Where simplified rules are given in the relevant clauses dealing with serviceability limit states, detailed calculations using combinations of actions are not required. When needed, the partial factor for materials, for the serviceability limit state, is γ_M .

NOTE The value to be ascribed to the symbol γ_M for use in a country may be found in its National Annex. The recommended value for γ_M , for all material properties for serviceability limit states is 1,0.

2.5 Design assisted by testing

(1) Structural properties of masonry may be determined by testing.

NOTE Annex D (informative) of EN 1990 gives recommendations for design assisted by testing.

Section 3 Materials

3.1 Masonry Units

3.1.1 Types and grouping of masonry units

(1)P Masonry units shall comply with any of the following types:

- clay units in accordance with EN 771-1.
- calcium silicate units in accordance with EN 771-2.
- aggregate concrete units (dense and lightweight aggregate) in accordance with EN 771-3.
- autoclaved aerated concrete units in accordance with EN 771-4.
- manufactured stone units in accordance with EN 771-5.
- dimensioned natural stone units in accordance with $\overline{\text{AC1}}$ EN 771-6 $\overline{\text{AC1}}$.

(2) Masonry units may be Category I or Category II.

NOTE The definitions of Category I and II units are given in EN 771-1 to 6.

(3) Masonry units should be grouped as Group 1, Group 2, Group 3 or Group 4, for the purposes of using the equations and other numerical values given in 3.6.1.2 (2), (3), (4), (5) and (6), and 3.6.1.3 and where grouping is referred to in other clauses.

NOTE Normally the manufacturer will state the grouping of his units.

(4) Autoclaved aerated concrete, manufactured stone and dimensioned natural stone units are considered to be Group 1. The geometrical requirements for grouping of clay, calcium silicate and aggregate concrete units are given in table 3.1.

Table 3.1 — Geometrical requirements for Grouping of Masonry Units

	Materials and limits for Masonry Units							
	Group 1 (all materials)		Group 2		Group 3		Group 4	
		Units	Vertical holes			Horizontal holes		
Volume of all holes (% of the gross volume)	≤ 25	clay	> 25; ≤ 55		≥ 25; ≤ 70		> 25; ≤ 70	
		calcium silicate	> 25; ≤ 55		not used		not used	
		concrete ^b	> 25; ≤ 60		> 25; ≤ 70		> 25; ≤ 50	
Volume of any hole (% of the gross volume)	≤ 12,5	clay	each of multiple holes ≤ 2 gripholes up to a total of 12,5		each of multiple holes ≤ 2 gripholes up to a total of 12,5		each of multiple holes ≤ 30	
		calcium silicate	each of multiple holes ≤ 15 gripholes up to a total of 30		not used		not used	
		concrete ^b	each of multiple holes ≤ 30 gripholes up to a total of 30		each of multiple holes ≤ 30 gripholes up to a total of 30		each of multiple holes ≤ 25	
Declared values of thickness of webs and shells (mm)	No requirement		web	shell	web	shell	web	shell
		clay	≥ 5	≥ 8	≥ 3	≥ 6	≥ 5	≥ 6
		calcium silicate	≥ 5	≥ 10	not used		not used	
		concrete ^b	≥ 15	≥ 18	≥ 15	≥ 15	≥ 20	≥ 20
Declared value of combined thickness ^a of webs and shells (% of the overall width)	No requirement	clay	≥ 16		≥ 12		≥ 12	
		calcium silicate	≥ 20		not used		not used	
		concrete ^b	≥ 18		≥ 15		≥ 45	
^a The combined thickness is the thickness of the webs and shells, measured horizontally in the relevant direction. The check is to be seen as a qualification test and need only be repeated in the case of principal changes to the design dimensions of units.								
^b In the case of conical holes, or cellular holes, use the mean value of the thickness of the webs and the shells.								

3.1.2 Properties of masonry units –compressive strength

(1)P The compressive strength of masonry units, to be used in design, shall be the normalised mean compressive strength, f_b .

NOTE In the EN 771 series of standards, the normalised mean compressive strength is either:

- declared by the manufacturer; or
- obtained by converting the compressive strength by using EN 772-1, Annex A (Conversion of the compressive strength of masonry units to the normalised mean compressive strength).

(2) When the manufacturer declares the normalised compressive strength of masonry units as a characteristic strength, this should be converted to the mean equivalent, using a factor based on the coefficient of variation of $\langle \overline{A_{C1}} \rangle$ the compressive strength of $\langle \overline{A_{C1}} \rangle$ the units.

3.2 Mortar

3.2.1 Types of masonry mortar

(1) Masonry mortars are defined as general purpose, thin layer or lightweight mortar according to their constituents.

(2) Masonry mortars are considered as designed or prescribed mortars according to the method of defining their composition.

(3) Masonry mortars may be factory made (pre-batched or pre-mixed), semi-finished factory made or site-made, according to the method of manufacture.

(4)P Factory made and semi-finished factory made masonry mortars shall be in accordance with EN 998-2. Site-made masonry mortar shall be in accordance with EN 1996-2. Pre-mixed lime and sand masonry mortar shall be in accordance with EN 998-2, and shall be used in accordance with EN 998-2.

3.2.2 Specification of masonry mortar

(1) Mortars should be classified by their compressive strength, expressed as the letter M followed by the compressive strength in N/mm², for example, M5. Prescribed masonry mortars, additionally to the M number, will be described by their prescribed constituents, e. g. 1: 1: 5 cement: lime: sand by volume.

NOTE The National Annex of a country may ascribe acceptable equivalent mixes, described by the proportion of the constituents, to stated M values. Such acceptable equivalent mixes should be given in the National Annex.

(2) General purpose masonry mortars may be designed mortars in accordance with EN 998-2 or prescribed masonry mortars in accordance with EN 998-2.

(3) Thin layer and lightweight masonry mortars should be designed mortars in accordance with EN 998-2.

3.2.3 Properties of mortar

3.2.3.1 Compressive strength of masonry mortar

(1)P The compressive strength of masonry mortar, f_m , shall be determined in accordance with EN 1015-11.

AC1 *Text deleted* AC1

3.2.3.2 Adhesion between units and mortar

(1)P The adhesion between the mortar and the masonry units shall be adequate for the intended use.

NOTE 1 Adequate adhesion will depend on the type of mortar used and the units to which that mortar is applied.

AC1 NOTE 2 EN 1052-3 deals with the determination of the initial shear strength of masonry and EN 1052-5 deals with the determination of flexural bond strength. AC1

3.3 Concrete infill

3.3.1 General

(1)P Concrete used for infill shall be in accordance with EN 206.

(2) Concrete infill is specified by the characteristic compressive strength, f_{ck} , (concrete strength class), which relates to the cylinder/cube strength at 28 days, in accordance with EN 206.

3.3.2 Specification for concrete infill

(1) The strength class, as defined in EN 206-1, of concrete infill should not be less than C12/15.

(2) The concrete may be designed or prescribed and should contain just sufficient water to provide the specified strength and to give adequate workability.

(3)P The workability of concrete infill shall be such as to ensure that voids will be completely filled, when the concrete is placed in accordance with EN 1996-2.

(4) The slump class S3 to S5 or flow class F4 to F6, in accordance with EN 206-1, will be satisfactory for most cases. In holes, where the smallest dimension is less than 85 mm, AC1 slump class S5 or flow class F6 AC1 should be used. Where high slump concretes are to be used, measures need to be taken to reduce the resulting high shrinkage of the concrete.

(5) The maximum aggregate size of concrete infill should not exceed 20 mm. When concrete infill is to be used in voids whose least dimension is less than 100 mm or when the cover to the reinforcement is less than 25 mm, the maximum aggregate size should not exceed 10 mm.

3.3.3 Properties of concrete infill

(1)P The characteristic compressive strength and shear strength of concrete infill shall be determined from tests on concrete specimens.

NOTE Test results may be obtained from tests carried out for the project, or be available from a database.

(2) Where test data are not available the characteristic compressive strength, f_{ck} , and the characteristic shear strength, f_{cvk} , of concrete infill may be taken from table 3.2.

Table 3.2 — Characteristic strengths of concrete infill

Strength class of concrete	C12/15	C16/20	C20/25	C25/30, or stronger
f_{ck} (N/mm ²)	12	16	20	25
f_{cvk} (N/mm ²)	0,27	0,33	0,39	0,45

3.4 Reinforcing steel

3.4.1 General

(1)P Reinforcing carbon steel shall be specified in accordance with $\boxed{AC1}$ EN 10080 $\langle AC1 \rangle$. Stainless steel and specially coated bars shall be specified separately.

(2)P The requirements for the properties of the reinforcement are for the material as placed in the hardened masonry or concrete infill. Operations carried out on site or during manufacture, that might damage the properties of the material shall be avoided.

$\boxed{AC1}$ NOTE EN 10080 refers to a yield strength R_e , which includes the characteristic, minimum and maximum values based on the long-term quality of production. In contrast f_{yk} is the characteristic yield stress based on only that reinforcement required for the structure. There is no direct relationship between f_{yk} and the characteristic R_e . However the methods of evaluation and verification of yield strength given in EN 10080 provide a sufficient check for obtaining f_{yk} . $\langle AC1 \rangle$

(3) Reinforcing steel may be carbon steel or austenitic stainless steel. Reinforcing steel may be plain or ribbed (high bond) and weldable.

(4) Detailed information on the properties of reinforcing steel is to be found in EN 1992-1-1.

3.4.2 Properties of reinforcing steel bars

(1)P The characteristic strength of reinforcing steel bars, f_{yk} , shall be in accordance with annex C of EN 1992-1-1

(2) The coefficient of thermal expansion may be assumed to be $12 \times 10^{-6} \text{ K}^{-1}$.

NOTE The difference between this value and the value for the surrounding masonry or concrete may normally be neglected.

$\boxed{AC1}$ 3.4.3 Properties of bed joint reinforcement $\langle AC1 \rangle$

(1)P Prefabricated bed joint reinforcement shall be in accordance with EN 845-3.

3.5 Prestressing steel

(1)P Prestressing steel shall be in accordance with EN 10138 or an appropriate European Technical Approval.

(2) The properties of prestressing steel should be obtained from EN 1992-1-1.

3.6 Mechanical properties of masonry

3.6.1 Characteristic compressive strength of masonry

3.6.1.1 General

(1)P The characteristic compressive strength of masonry, f_k , shall be determined from results of tests on masonry specimens.

NOTE Test results may be obtained from tests carried out for the project, or be available from a database.

3.6.1.2 Characteristic compressive strength of masonry other than shell bedded masonry

(1) The characteristic compressive strength of masonry should be determined from either:

(i) results of tests in accordance with EN 1052-1 which tests may be carried out for the project or be available from tests previously carried out e.g. a database; the results of the tests should be expressed as a table, or in terms of equation (3.1).

$$f_k = K f_b^\alpha f_m^\beta \quad (3.1)$$

where:

f_k is the characteristic compressive strength of the masonry, in N/mm²

K is a constant and, where relevant, modified according to 3.6.1.2(3) $\langle AC1 \rangle$ and/or $\langle AC1 \rangle$ 3.6.1.2(6)

α, β are constants

f_b is the normalised mean compressive strength of the units, in the direction of the applied action effect, in N/mm²

f_m is the compressive strength of the mortar, in N/mm²

Limitations on the use of equation (3.1) should be given in terms of f_b, f_m , the coefficient of variation of the test results, and the Grouping of the units.

or

(ii) from (2) and (3), below.

NOTE The decision on which of methods (i) and (ii) is to be used in a country may be found in its National Annex. If (i) is used, tabulated values or the constants to be used in equation (3.1) and the limitations, preferably referring to the grouping in Table 3.1, should be given in the National Annex.

(2) The relationship between the characteristic compressive strength of masonry, f_k , the normalised mean compressive strength of the units, f_b , and the mortar strength, f_m , may be obtained from:

- equation (3.2), for masonry made with general purpose mortar and lightweight mortar;
- equation (3.3), for masonry made with thin layer mortar, in bed joints of thickness 0,5 mm to 3 mm, and clay units of Group 1 and 4, calcium silicate, aggregate $\boxed{\text{AC1}}$ concrete $\langle \text{AC1} \rangle$ and autoclaved aerated concrete units;
- equation (3.4), for $\boxed{\text{AC1}}$ masonry made $\langle \text{AC1} \rangle$ with thin layer mortar, in bed joints of thickness 0,5 mm to 3 mm, and clay units of Group 2 and 3.

NOTE EN 998-2 gives no limit for the thickness of joints made of thin layer mortar; the limit on the thickness of bed joints of $\boxed{\text{AC1}}$ 0,5 mm $\langle \text{AC1} \rangle$ to 3 mm is to ensure that the thin layer mortar has the enhanced properties assumed to exist to enable equations (3.3) and (3.4) to be valid. The mortar strength, f_m , does not need to be used with equation (3.3) and (3.4).

$$\boxed{\text{AC1}} f_k = K f_b^{0,7} f_m^{0,3} \quad (3.2) \quad \langle \text{AC1} \rangle$$

$$f_k = K f_b^{0,85} \quad (3.3)$$

$$f_k = K f_b^{0,7} \quad (3.4)$$

where:

K is a constant according to table 3.3, and where relevant, modified according to 3.6.1.2(3) and or 3.6.1.2(6)

provided that the following requirements are satisfied:

- the masonry is detailed in accordance with section 8 of this EN 1996-1-1;
- all joints satisfy the requirements of 8.1.5 (1) and (3) so as to be considered as filled;
- f_b is not taken to be greater than 75 N/mm² when units are laid in general purpose mortar
- f_b is not taken to be greater than 50 N/mm² when units are laid in thin layer mortar;
- f_m is not taken to be greater than 20 N/mm² nor greater than 2 f_b when units are laid in general purpose mortar;
- f_m is not taken to be greater than 10 N/mm² when units are laid in lightweight mortar;
- the thickness of the masonry is equal to the width or length of the unit, so that there is no mortar joint parallel to the face of the wall through all or any part of the length of the wall;
- the coefficient of variation of the strength of the masonry units is not more than 25 %.

(3) Where action effects are parallel to the direction of the bed joints, the characteristic compressive strength may also be determined from equations (3.2), (3.3) or (3.4), using the normalized compressive strength of the masonry unit, f_b , obtained from tests where the direction of application of the load to the test specimen is the same as the direction of the action effect in the masonry, but with the factor, δ , as given in EN 772-1, not taken to be greater than 1,0. For Group 2 and 3 units, K should then be multiplied by 0,5.

(4) For masonry made of general purpose mortar where Group 2 and Group 3 aggregate concrete units are used with the vertical cavities filled completely with concrete, the value of f_b should be obtained by considering the units to be Group 1 with a compressive strength corresponding to the compressive strength of the units or of the concrete infill, whichever is the lesser.

(5) When the perpendicular joints are unfilled, equations (3.2), (3.3) or (3.4) may be used, considering any horizontal actions that might be applied to, or be transmitted by, the masonry. See also 3.6.2(4).

(6) For masonry made with general purpose mortar where there is a mortar joint parallel to the face of the wall through all or any part of the length of the wall, the values of K can be obtained by multiplying the values given in table 3.3 by 0,8.

Table 3.3 — Values of K for use with general purpose, thin layer and lightweight mortars

Masonry Unit		General purpose mortar	Thin layer mortar (bed joint $\geq 0,5$ mm and ≤ 3 mm)	Lightweight mortar of density	
				$600 \leq \rho_d \leq 800$ kg/m ³	$800 < \rho_d \leq 1300$ kg/m ³
Clay	Group 1	0,55	0,75	0,30	0,40
	Group 2	0,45	0,70	0,25	0,30
	Group 3	0,35	0,50	0,20	0,25
	Group 4	0,35	0,35	0,20	0,25
Calcium Silicate	Group 1	0,55	0,80	‡	‡
	Group 2	0,45	0,65	‡	‡
Aggregate Concrete	Group 1	0,55	0,80	0,45	0,45
	Group 2	0,45	0,65	0,45	0,45
	Group 3	0,40	0,50	‡	‡
	Group 4	0,35	‡	‡	‡
Autoclaved Aerated Concrete	Group 1	0,55	0,80	0,45	0,45
Manufactured Stone	Group 1	0,45	0,75	‡	‡
Dimensioned Natural Stone	Group 1	0,45	‡	‡	‡

‡ Combination of mortar/unit not normally used, so no value given.

3.6.1.3 Characteristic compressive strength of shell bedded masonry

AC1(1) The characteristic compressive strength of shell bedded masonry may also be obtained from 3.6.1.2 using the normalised mean compressive strength of the units f_b that is obtained for normal bedding (thus not obtained from tests on units tested in accordance with EN 772-1 for shell bedded units), provided that: **AC1**

- the width of each strip of mortar is 30 mm or greater;
- the thickness of the masonry is equal to the width or length of the masonry units so that there is no longitudinal mortar joint through all or part of the length of the wall;
- the ratio g/t is not less than 0,4;
- K is taken from 3.6.1.2 when $g/t = 1,0$ or K is taken as half of those values when $g/t = 0,4$, with intermediate values obtained by linear interpolation,

where:

g is the total of the widths of the mortar strips;

t is the thickness of the wall.

(2) The characteristic compressive strength of shell bedded masonry **AC1** *Text deleted* **AC1** may be obtained from 3.6.1.2, provided that the normalised mean compressive strength of the units, f_b , used in the equation is that obtained from tests on units tested in accordance with EN 772-1 for shell bedded units.

3.6.2 Characteristic shear strength of masonry

(1)P The characteristic shear strength of masonry, f_{vk} , shall be determined from the results of tests on masonry.

NOTE Test results may be obtained from tests carried out for the project, or be available from a database.

(2) The characteristic initial shear strength of masonry, f_{vko} , should be determined from tests in accordance with EN 1052-3 or EN 1052-4.

(3) The characteristic shear strength of masonry, f_{vk} , using general purpose mortar in accordance with 3.2.2(2), or thin layer mortar in beds of thickness 0,5 mm to 3,0 mm, in accordance with 3.2.2(3), or lightweight mortar in accordance with 3.2.2(4) with all joints satisfying the requirements of 8.1.5 so as to be considered as filled, may be taken from equation (3.5).

$$f_{vk} = f_{vko} + 0,4 \sigma_d \quad (3.5)$$

but not greater than $0,065 f_b$ or f_{vlt}

where:

f_{vko} is the characteristic initial shear strength, under zero compressive stress;

f_{vlt} is a limit to the value of f_{vk} ;

σ_d is the design compressive stress perpendicular to the shear in the member at the level under consideration, using the appropriate load combination based on the average vertical stress over the compressed part of the wall that is providing shear resistance;

f_b is the normalised compressive strength of the masonry units, as described in 3.1.2.1, for the direction of application of the load on the test specimens being perpendicular to the bed face.

NOTE The decision on whether to use $0,065 f_b$ or f_{vlt} in a country, and the values or derivation of f_{vlt} related to e.g. the tensile strength of the units and/or overlap in the masonry, if that option is chosen, may be found in its National Annex.

(4) The characteristic shear strength of masonry using general purpose mortar in accordance with 3.2.2(2), or thin layer mortar in accordance with 3.2.2(3), in beds of thickness 0,5 mm to 3,0 mm, or lightweight mortar in accordance with 3.2.2(4), and having the perpend joints unfilled, but with adjacent faces of the masonry units closely abutted together, may be taken from equation (3.6).

$$f_{vk} = 0,5 f_{vko} + 0,4 \sigma_d \quad (3.6)$$

but not greater than $0,045 f_b$ or f_{vlt}

where:

f_{vko} , f_{vlt} , σ_d and f_b are as defined in (3) above.

NOTE The decision on whether to use $\boxed{AC1}$ $0,045 \boxed{AC1}$ f_b or f_{vlt} in a country, and the values or derivation of f_{vlt} related to e.g. the tensile strength of the units and/or overlap in the masonry, if that option is chosen, may be found in its National Annex.

(5) In shell bedded masonry, where the units are bedded on two or more equal strips of general purpose mortar, each at least 30 mm in width, f_{vk} may be taken from equation (3.7).

$$f_{vk} = \frac{g}{t} f_{vko} + 0,4 \sigma_d \quad (3.7)$$

but not greater than would be obtained from (4) above.

where:

f_{vk} , σ_d and f_b are as defined in (3) above and:

g is the total of the widths of the mortar strips;

t is the thickness of the wall.

(6) The initial shear strength of the masonry, f_{vko} , may be determined from either:

— the evaluation of a database on the results of tests on the initial shear strength of masonry,

or

— from the values given in table 3.4, provided that general purpose mortars made in accordance with EN 1996-2 do not contain admixtures or additives.

NOTE The decision on which of the above two methods is to be used in a country may be found in its National Annex. When a country decides to determine its values of f_{vko} from a database, the values may be given in the National Annex.

(7) The vertical shear resistance of the junction of two masonry walls may be obtained from suitable tests for a specific project or it may be taken from an evaluation of test data. In the absence of such data, the characteristic vertical shear resistance may be based on f_{vko} , where f_{vko} is the shear strength under zero compressive stress, as given in 3.6.2(2) and (6), provided that the connection between the walls is in accordance with 8.5.2.1.

Table 3.4 — Values of the $\langle AC_1 \rangle$ initial $\langle AC_1 \rangle$ shear strength of masonry, f_{vko}

Masonry units	f_{vko} (N/mm ²)			
	General purpose mortar of the Strength Class given		Thin layer mortar (bed joint \geq 0,5 mm and \leq 3 mm)	Lightweight mortar
Clay	M10 - M20	0,30	0,30	0,15
	M2,5 - M9	0,20		
	M1 - M2	0,10		
Calcium silicate	M10 - M20	0,20	0,40	0,15
	M2,5 - M9	0,15		
	M1 - M2	0,10		
Aggregate concrete	M10 - M20	0,20	0,30	0,15
Autoclaved Aerated Concrete	M2,5 - M9	0,15		
Manufactured stone and Dimensioned natural stone	M1 - M2	0,10		

3.6.3 Characteristic flexural strength of masonry

(1) In relation to out-of plane bending, the following situations should be considered: flexural strength having a plane of failure parallel to the bedjoints, f_{xk1} ; flexural strength having a plane of failure perpendicular to the bedjoints, f_{xk2} (see figure 3.1).

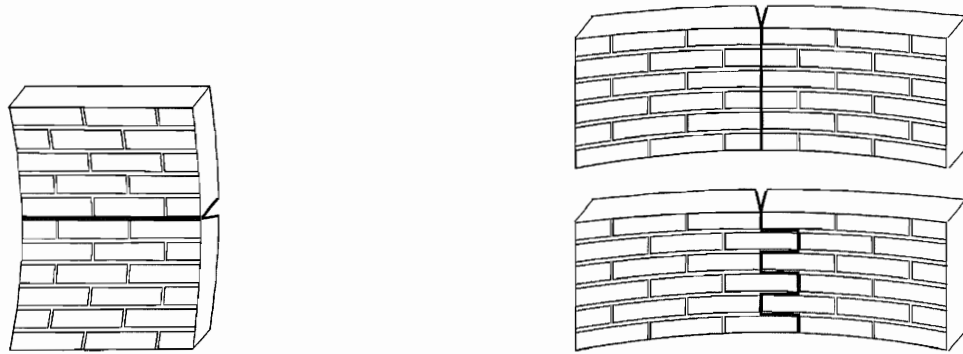

a) plane of failure parallel to bed joints, f_{xk1} b) plane of failure perpendicular to bed joints, f_{xk2}

Figure 3.1 — Planes of failure of masonry in bending

(2)P The characteristic flexural strength of masonry, f_{xk1} and f_{xk2} , shall be determined from the results of tests on masonry.

NOTE Tests results may be obtained from tests carried out for the project, or be available from a database.

(3) The characteristic flexural strength of masonry may be determined by tests in accordance with EN 1052-2, or it may be established from an evaluation of test data based on the flexural strengths of masonry obtained from appropriate combinations of units and mortar.

NOTE 1 Values of f_{xk1} and f_{xk2} to be used in a country may be found in its National Annex.

NOTE 2 Where test data are not available values of the characteristic flexural strength of masonry made with general purpose mortar, thin layer mortar or lightweight mortar, may be taken from the tables in this note, provided that thin layer mortar and lightweight mortars are M5, or stronger.

NOTE 3 For masonry made with autoclaved aerated concrete units laid in thin layer mortar, f_{xk1} and f_{xk2} values may be taken from the tables in this note or from the following equations:

$$f_{xk1} = 0,035 f_b, \text{ with filled and unfilled perpend joints}$$

$$f_{xk2} = 0,035 f_b, \text{ with filled perpend joints or } 0,025 f_b, \text{ with unfilled perpend joints}$$

Values of f_{xk1} , for plane of failure parallel to bed joints

Masonry Unit	f_{xk1} (N/mm ²)			
	General purpose mortar		Thin layer mortar	Lightweight mortar
	$f_m < 5$ N/mm ²	$f_m \geq 5$ N/mm ²		
Clay	0,10	0,10	0,15	0,10
Calcium silicate	0,05	0,10	0,20	not used
Aggregate concrete	0,05	0,10	0,20	not used
Autoclaved aerated concrete	0,05	0,10	0,15	0,10
Manufactured stone	0,05	0,10	not used	not used
Dimensioned natural stone	0,05	0,10	0,15	not used

Values of f_{xk2} , for plane of failure perpendicular to bed joints

Masonry Unit		f_{xk2} (N/mm ²)			
		General purpose mortar		Thin layer mortar	Lightweight mortar
		$f_m < 5$ N/mm ²	$f_m \geq 5$ N/mm ²		
Clay		0,20	0,40	0,15	0,10
Calcium silicate		0,20	0,40	0,30	not used
Aggregate concrete		0,20	0,40	0,30	not used
Autoclaved aerated concrete	$\rho < 400$ kg/m ³	0,20	0,20	0,20	0,15
	$\rho \geq 400$ kg/m ³	0,20	0,40	0,30	0,15
Manufactured stone		0,20	0,40	not used	not used
Dimensioned natural stone		0,20	0,40	0,15	not used

NOTE 4 f_{xk2} should not be taken to be greater than the flexural strength of the unit.

END OF NOTES.

3.6.4 Characteristic anchorage strength of reinforcement

(1)P The characteristic anchorage strength of reinforcement bedded in mortar or concrete shall be obtained from the results of tests.

NOTE Test results may be obtained from tests carried out for the project, or be available from a database.

(2) The characteristic anchorage strength of reinforcement may be established from an evaluation of test data.

(3) Where test data are not available, for reinforcement embedded in concrete sections with dimensions greater than or equal to 150 mm, or where the concrete infill surrounding the reinforcement is confined within masonry units, so that the reinforcement can be considered to be confined, the characteristic anchorage strength, f_{bok} , is given in table 3.5.

(4) For reinforcement embedded in mortar, or in concrete sections with dimensions less than 150 mm, or where the concrete infill surrounding the reinforcement is not confined within masonry units so that the reinforcement is considered not to be confined, the characteristic anchorage strength, f_{bok} , is given in table 3.6.

(5) For prefabricated bed joint reinforcement, the characteristic anchorage strength should be determined by tests in accordance with EN 846-2, or the bond strength of the longitudinal wires alone should be used.

Table 3.5 — Characteristic anchorage strength of reinforcement in confined concrete infill

Strength class of concrete	C12/15	C16/20	C20/25	C25/30 or stronger
f_{bok} for plain carbon steel bars (N/mm ²)	1,3	1,5	1,6	1,8
f_{bok} for high-bond carbon and stainless steel bars (N/mm ²)	2,4	3,0	3,4	4,1

Table 3.6 — Characteristic anchorage strength of reinforcement in mortar or concrete not confined within masonry units

Strength class of	Mortar	M2-M4	M5-M9	M10-M14	M15-M19	M20
	Concrete	not used	C12/15	C16/20	C20/25	C25/30 or stronger
f_{bok} for plain carbon steel bars (N/mm ²)		0,5	0,7	1,2	1,4	1,4
f_{bok} for high-bond carbon steel and stainless steel bars (N/mm ²)		0,5	1,0	1,5	2,0	3,4

3.7 Deformation properties of masonry

3.7.1 Stress-strain relationship

(1) The stress-strain relationship of masonry in compression is non-linear and may be taken as linear, parabolic, parabolic rectangular (see figure 3.2) or as rectangular, for the purposes of designing a masonry section (see 6.6.1(1)P).

NOTE Figure 3.2 is an approximation and may not be suitable for all types of masonry units.

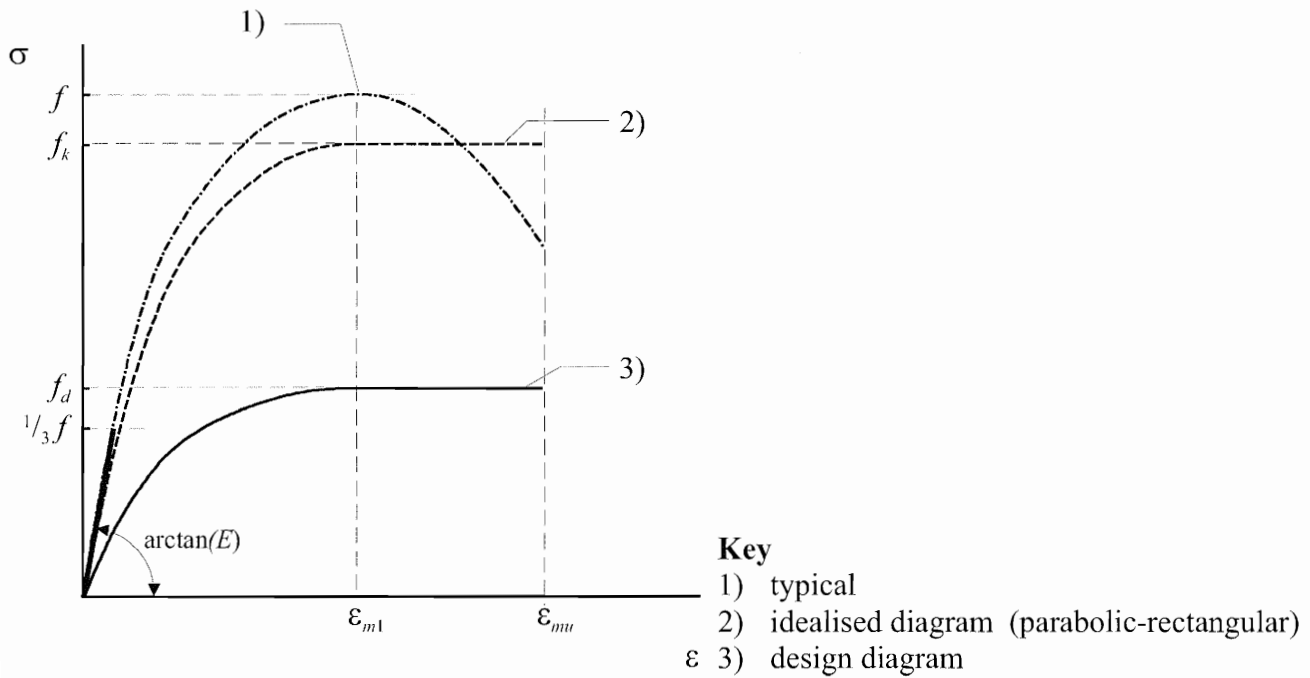

Figure 3.2 — Stress-strain relationship for masonry in compression

3.7.2 Modulus of elasticity

(1)P The short term secant modulus of elasticity, E , shall be determined by tests in accordance with EN 1052-1.

NOTE Test results may be obtained from tests carried out for the project, or be available from a database.

(2) In the absence of a value determined by tests in accordance with EN 1052-1, the short term secant modulus of elasticity of masonry, E , for use in structural analysis, may be taken to be $K_E f_k$.

NOTE The values of K_E to be used in a country may be found in its National Annex. The recommended value of K_E is 1 000.

(3) The long term modulus should be based on the short term secant value, reduced to allow for creep effects, (see 3.7.4), such that:

$$E_{\text{long term}} = \frac{E}{1 + \phi_{\infty}} \quad (3.8)$$

where:

ϕ_{∞} is the final creep coefficient.

3.7.3 Shear modulus

(1) The shear modulus, G , may be taken as 40 % of the elastic modulus, E .

3.7.4 Creep, moisture expansion or shrinkage and thermal expansion

(1)P Coefficients of creep, moisture expansion or shrinkage and thermal expansion shall be determined by test.

NOTE 1 Test results may be obtained from tests carried out for the project, or be available from a database.

NOTE 2 No European test method to determine creep or moisture expansion for masonry currently exists.

(2) The final creep coefficient, ϕ_{∞} , long term moisture expansion or shrinkage, or the coefficient of thermal expansion, α_t , should be obtained from an evaluation of test data.

NOTE Ranges of values for the deformation properties of masonry are given in the table below. The values to be used in a country may be found in its National Annex

Ranges of coefficients of creep, moisture expansion or shrinkage, and thermal properties of masonry

Type of masonry unit	Final creep coefficient ^a ϕ_{∞}	Long term moisture expansion or shrinkage ^b mm/m	Coefficient of thermal expansion, α_t , $10^{-6}/K$
Clay	0,5 to 1,5	-0,2 to +1,0	4 to 8
Calcium Silicate	1,0 to 2,0	-0,4 to -0,1	7 to 11
Dense aggregate concrete and manufactured stone	1,0 to 2,0	-0,6 to -0,1	6 to 12
Lightweight aggregate concrete	1,0 to 3,0	-1,0 to -0,2	6 to 12
Autoclaved aerated concrete	0,5 to 1,5	-0,4 to +0,2	7 to 9
Natural stone	Magmatic	c	5 to 9
	Sedimentary		2 to 7
	Metamorphic		1 to 18

^a The final creep coefficient $\phi_{\infty} = \epsilon_{c\infty} / \epsilon_{cl}$, where $\epsilon_{c\infty}$ is the final creep strain and $\epsilon_{cl} = \sigma / E$.

^b Where the long term value of moisture expansion or shrinkage is shown as a negative number it indicates shortening and as a positive number it indicates expansion.

^c These values are normally very low.

END OF NOTE

3.8 Ancillary components

3.8.1 Damp proof courses

(1)P Damp proof courses shall resist the passage of (capillary) water.

3.8.2 Wall ties

(1)P Wall ties shall be in accordance with EN 845-1.

3.8.3 Straps, hangers and brackets

(1)P Straps, hangers and brackets shall be in accordance with EN 845-1.

3.8.4 Prefabricated lintels

(1)P Prefabricated lintels shall be in accordance with EN 845-2

3.8.5 Prestressing devices

(1)P Anchorages, couplers, ducts and sheaths shall be in accordance with the requirements of EN 1992-1-1.

Section 4 Durability

4.1 General

(1)P Masonry shall be designed to have the durability required for its intended use, taking into account the relevant environmental conditions.

4.2 Classification of environmental conditions

(1) The classification of environmental conditions should be in accordance with EN 1996-2.

4.3 Durability of masonry

4.3.1 Masonry units

(1)P Masonry units shall be sufficiently durable to resist the relevant exposure conditions for the intended life of the building.

NOTE Guidance on design and construction to provide adequate durability is given in EN 1996-2

4.3.2 Mortar

(1)P Mortar in masonry shall be sufficiently durable to resist relevant micro exposure conditions for the intended life of the building, and shall not contain constituents which can have a detrimental effect on the properties or durability of the mortar or abutting materials.

NOTE Guidance on design and construction to achieve adequate durability of mortar joints is given in section 8 of this EN 1996-1-1 and EN 1996-2.

4.3.3 Reinforcing steel

(1)P Reinforcing steel shall be sufficiently durable, either by being corrosion resistant or adequately protected, so that, when placed in accordance with the application rules in section 8, it will resist local exposure conditions for the intended life of the building.

(2) Where carbon steel requires protection to provide adequate durability, it should be galvanised in accordance with $\text{prEN 10348} \text{ (AC1)}$, such that the zinc coating is not less than that required to provide

the necessary durability (see (3), below) or the steel should be given an equivalent protection such as by fusion bonded epoxy powder.

(3) The type of reinforcing steel, and the minimum level of protection for the reinforcing steel, should be chosen with regard to the relevant exposure class of the place of use.

NOTE Recommended reinforcing steels for durability may be found in the National Annex. A table of recommendations is given below.

AC1 Selection of reinforcing steel for durability AC1

Exposure class ^a	Minimum level of protection for reinforcing steel	
	Located in mortar	Located in concrete with cover less than required according to (4)
MX1	Unprotected carbon steel ^b	Unprotected carbon steel
MX2	Carbon steel, heavily galvanised or with equivalent protection ^c	Unprotected carbon steel or, where mortar is used to fill in the voids, carbon steel, heavily galvanised or with equivalent protection ^c
	Unprotected carbon steel, in masonry with a rendering mortar on the exposed face ^d	
MX3	Austenitic stainless steel AISI 316 or 304	Carbon steel, heavily galvanised or with equivalent protection ^c
	Unprotected carbon steel, in masonry with a rendering mortar on the exposed face ^d	
MX4	Austenitic stainless steel AISI 316 Carbon steel heavily galvanised or with equivalent protection ^b with a rendering mortar on the exposed face ^d	Austenitic stainless steel AISI 316
MX5	Austenitic stainless steel AISI 316 or 304 ^e	Austenitic stainless steel AISI 316 or 304 ^e

^a See EN 1996-2

^b For the inner leaf of external cavity walls likely to become damp, carbon steel, heavily galvanised or with equivalent protection as c, should be used.

AC1 ^c Carbon steel should be galvanised with a minimum mass of zinc coating of 900 g/m² or galvanised with a minimum mass of zinc coating of 60 g/m² and provided with a bonded epoxy coating of at least 80 µm thickness, with an average of 100 µm. See also 3.4. **AC1**

^d The mortar should be general purpose or thin layer mortar, not less than M4, the side cover in figure 8.2 should be increased to 30 mm and the masonry should be rendered with a rendering mortar in accordance with EN 998-1.

^e Austenitic stainless steel may still not be suitable for all aggressive environments, and these should be considered on a project by project basis.

END OF NOTE

(4) Where unprotected carbon steel is used, it should be protected by concrete cover of depth c_{nom} .

NOTE Values of c_{nom} to be used in a country will be found in its National Annex. Recommended values are given in the following table.

AC1 Recommended values for the minimum concrete cover c_{nom} for carbon reinforced steel AC1

Exposure class	Minimum cement content ^a				
	kg/m ³				
	275	300	325	350	400
	Maximum water/cement ratio				
	0,65	0,60	0,55	0,50	0,45
	Thickness of minimum concrete cover				
	mm				
MX1 ^b	20	20	20 ^c	20 ^c	20 ^c
MX2	—	35	30	25	20
MX3	—	—	40	30	25
MX4 and MX5	—	—	—	60 ^d	50

^a All mixes are based on the use of normal-weight aggregate of 20 mm nominal maximum size. Where other sized aggregates are used, cement contents should be adjusted by +20 % for 14 mm aggregate and +40 % for 10 mm aggregate.

^b Alternatively, a 1: 0 to ¼ : 3: 2 (cement : lime: sand : 10 mm nominal aggregate mix by volume) may be used to meet exposure situation MX1, when the cover to reinforcement is a minimum of 15 mm.

^c These covers may be reduced to a minimum of 15 mm provided that the nominal maximum size of the aggregate does not exceed 10 mm.

^d Where the concrete infill may be subjected to freezing while still wet, frost resistant concrete should be used.

END OF NOTE

(5) Where galvanising is used to provide protection, the reinforcing steel should be galvanised after it has been bent to shape.

(6) For prefabricated bed joint reinforcement, EN 845-3 lists the protection systems that are to be declared by the manufacturer.

4.3.4 Prestressing steel

(1)P Prestressing steel shall be sufficiently durable, when placed in accordance with the application rules in section 8, to resist relevant micro exposure conditions for the intended life of the building.

(2) When prestressing steel is to be galvanised it should be of such a composition that it will not be adversely affected by the galvanising process.

4.3.5 Prestressing devices

(1)P Anchorages, couplers, ducts and sheaths shall be corrosion resistant in the environmental condition in which they are used.

4.3.6 Ancillary components and support angles

(1) EN 1996-2 gives requirements for the durability of ancillary components (damp proof courses, wall ties, straps, hangers and brackets, and support angles).

4.4 Masonry below ground

(1)P Masonry below ground shall be such that it is not adversely affected by the ground conditions or it shall be suitably protected there from.

(2) Measures should be taken to protect masonry that may be damaged by the effects of moisture when in contact with the ground.

(3) When the soil is likely to contain chemicals, which might be harmful to the masonry, the masonry should be constructed of materials resistant to the chemicals or it should be protected in such a way that the aggressive chemicals cannot be transmitted into it.

Section 5 Structural analysis

5.1 General

(1)P For each relevant limit state verification, a calculation model of the structure shall be set up from:

- an appropriate description of the structure, the materials from which it is made, and the relevant environment of its location;
- the behaviour of the whole or parts of the structure, related to the relevant limit state;
- the actions and how they are imposed.

(2)P The general arrangement of the structure and the interaction and connection of its various parts shall be such as to give appropriate stability and robustness during construction and use.

(3) Calculation models may be based on separate parts of the structure (such as walls) independently, provided that 5.1(2)P is satisfied.

NOTE Where the structure is made of separately designed components the overall stability and robustness should be ensured.

(4) The response of the structure should be calculated using either

- non linear theory, assuming a specific relationship between stress and strain (see 3.7.1)

or

— linear theory of elasticity, assuming a linear relationship between stress and strain with a slope equal to the short term secant modulus of elasticity (see 3.7.2).

(5) The results obtained from analysis of the calculation models should provide, in any member,

- the axial loads due to vertical and horizontal actions;
- the shear loads due to vertical and/or horizontal actions;
- the bending moments due to vertical and/or lateral actions;
- the torsional moments, if applicable.

(6)P Structural members shall be verified in the ultimate limit state and the serviceability limit state, using, as actions, the results obtained from the analysis.

(7) Design rules for verification in the ultimate limit state and the serviceability limit state are given in Sections 6 and 7.

5.2 Structural behaviour in accidental situations (other than earthquakes and fire)

(1)P In addition to designing the structure to support loads arising from normal use, it shall be ensured that there is a reasonable probability that it will not be damaged under the effect of misuse or accident to an extent disproportionate to the original cause.

NOTE No structure can be expected to be resistant to the excessive loads or forces, or loss of bearing members or portions of the structure that could arise due to an extreme cause. For example in a small building the primary damage may cause total destruction.

(2) The structural behaviour under accidental situations should be considered using one of the following methods:

- members designed to resist the effects of accidental actions given in EN 1991-1-7;
- the hypothetical removal of essential loadbearing members in turn
- use of a tie-ing system;
- reducing the risk of accidental actions, such as the use of impact barriers against vehicle impact.

5.3 Imperfections

(1)P Imperfections shall be taken into account in design.

(2) The possible effects of imperfections should be allowed for by assuming that the structure is inclined at an angle $\nu = \frac{1}{(100 \sqrt{h_{\text{tot}}})}$ radians to the vertical,

where:

h_{tot} is the total height of the structure in metres.

The resulting horizontal action should be added to the other actions.

5.4 Second order effects

(1) Structures incorporating masonry walls designed according to this EN 1996-1-1 shall have their parts braced together adequately so that sway of the structure is either prevented or allowed for by calculation.

(2) No allowance for sway of the structure is necessary if the vertical stiffening elements satisfy equation (5.1) in the relevant direction of bending at the bottom of the building:

$$h_{\text{tot}} \sqrt{\frac{N_{\text{Ed}}}{\sum EI}} \leq 0,6 \quad \text{for } n \geq 4 \quad (5.1)$$

$$\leq 0,2 + 0,1 n \quad \text{for } 1 \leq n \leq 4$$

where:

h_{tot} is the total height of the structure from the top of the foundation;

N_{Ed} is the design value of the vertical load (at the bottom of the building);

$\sum EI$ is the sum of the bending stiffnesses of all vertical stiffening building elements in the relevant direction;

NOTE Openings in vertical stiffening elements of less than 2 m² with heights not exceeding 0,6 h may be neglected.

n is the number of storeys.

(3) When the stiffening elements do not satisfy 5.4(2), calculations should be carried out to check that any sway can be resisted.

NOTE A method for calculating the eccentricity of a stability core due to sway is given in Annex B

5.5 Analysis of structural members

5.5.1 Masonry walls subjected to vertical loading

5.5.1.1 General

(1) When analysing walls subjected to vertical loading, allowance in the design should be made for the following:

- vertical loads directly applied to the wall;
- second order effects;
- eccentricities calculated from a knowledge of the layout of the walls, the interaction of the floors and the stiffening walls;
- eccentricities resulting from construction deviations and differences in the material properties of individual components.

NOTE See EN 1996-2 for permitted construction deviations.

(2) The bending moments may be calculated from the material properties given in Section 3, the joint behaviour, and from the principles of structural mechanics.

NOTE A simplified method for calculating the bending moments in walls due to vertical loading is given in Annex C. Annex C(4) and C(5) may be used with any calculation, including linear elastic theory.

(3)P An initial eccentricity, e_{init} , shall be assumed for the full height of a wall to allow for construction imperfections.

(4) The initial eccentricity, e_{init} , may be assumed to be $h_{ef}/450$, where h_{ef} is the effective height of the wall, calculated from 5.5.1.2.

5.5.1.2 Effective height of masonry walls

(1)P The effective height of a loadbearing wall shall be assessed taking account of the relative stiffness of the elements of structure connected to the wall and the efficiency of the connections.

(2) A wall may be stiffened by floors, or roofs, suitably placed cross walls, or any other similarly rigid structural elements to which the wall is connected.

(3) Walls may be considered as stiffened at a vertical edge if:

— cracking between the wall and its stiffening wall is not expected to occur i.e. both walls are made of materials with approximately similar deformation behaviour, are approximately evenly loaded, are erected simultaneously and bonded together and differential movement between the walls, for example, due to shrinkage, loading etc, is not expected

or

— the connection between a wall and its stiffening wall can resist tension and compression forces by anchors or ties or other suitable means.

(4) Stiffening walls should have a length of at least 1/5 of the clear height and have a thickness of at least 0,3 times the effective thickness of the wall to be stiffened.

(5) If the stiffening wall is interrupted by openings, the minimum length of the wall between openings, encompassing the stiffened wall, should be as shown in figure 5.1, and the stiffening wall should extend a distance of at least 1/5 of the storey height beyond each opening.

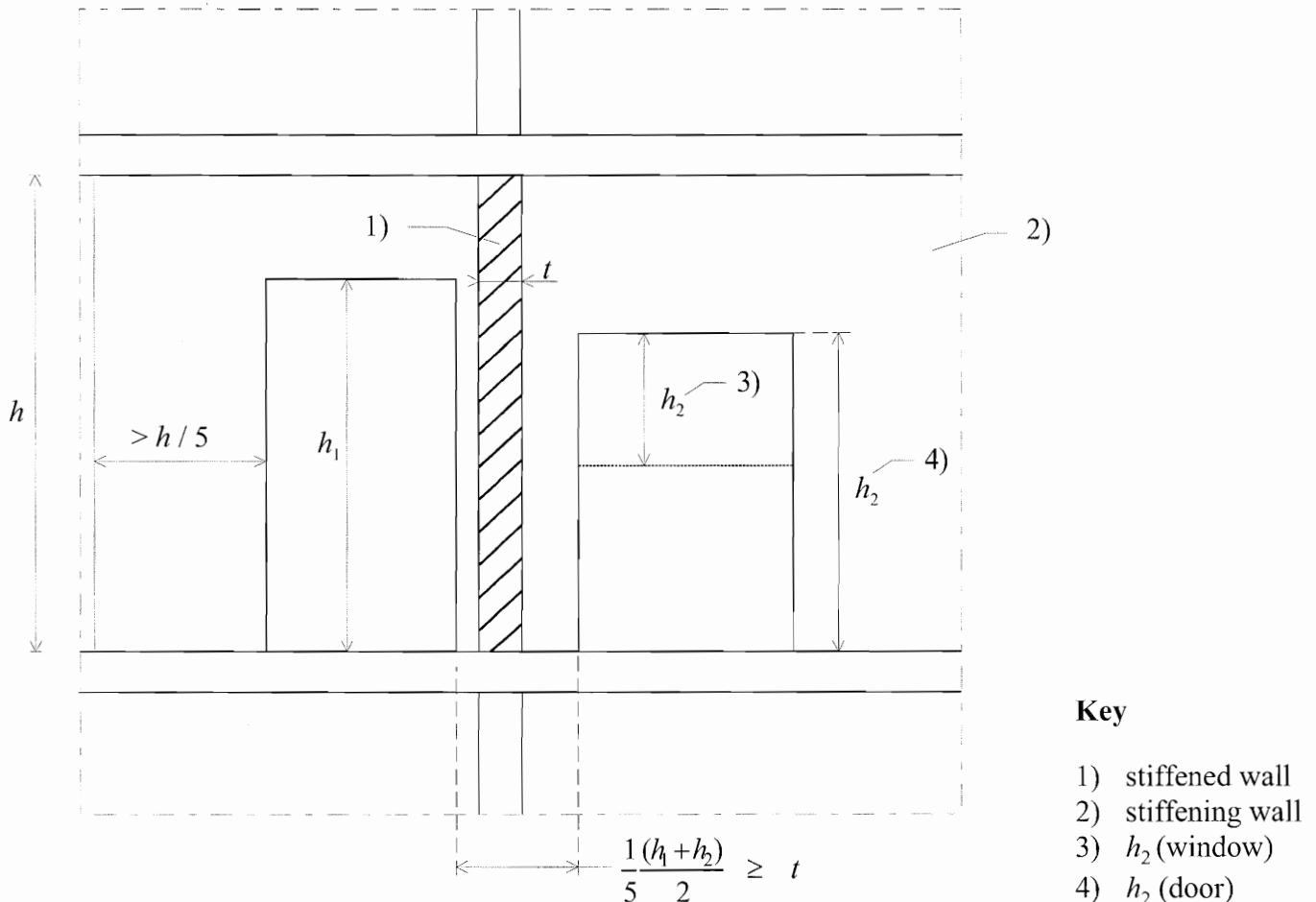

Figure 5.1 — Minimum length of stiffening wall with openings

(6) Walls may be stiffened by members other than masonry walls provided that such members have the equivalent stiffness of the masonry stiffening wall, described in paragraph (4) above, and they are connected to the stiffened wall with anchors or ties designed to resist the tension and compression forces that will develop.

(7) Walls stiffened on two vertical edges, with $l \geq 30 t$, or walls stiffened on one vertical edge, with $l \geq 15 t$, where l is the length of the wall, between the stiffening walls or an edge and t is the thickness of the stiffened wall, should be treated as walls restrained at top and bottom only.

(8) If the stiffened wall is weakened by vertical chases and/or recesses, other than those allowed by 6.1.2.1(7), the reduced thickness of the wall should be used for t , or a free edge should be assumed at the position of the vertical chase or recess. A free edge should always be assumed when the thickness of the wall remaining after the vertical chase or recess has been formed is less than half the wall thickness.

(9) Walls with openings having a clear height of more than 1/4 of the clear height of the wall or a clear width of more than 1/4 of the wall length or an area of more than 1/10 of the total area of the wall, should be considered as having a free edge at the edge of the opening for the purposes of determining the effective height.

(10) The effective height of a wall should be taken as:

$$h_{cf} = \rho_n h \quad (5.2)$$

where:

h_{cf} is the effective height of the wall;

h is the clear storey height of the wall;

ρ_n is a reduction factor where $n = 2, 3$ or 4 depending on the edge restraint or stiffening of the wall.

(11) The reduction factor, ρ_n , may be assumed to be:

(i) For walls restrained at the top and bottom by reinforced concrete floors or roofs spanning from both sides at the same level or by a reinforced concrete floor spanning from one side only and having a bearing of at least $2/3$ of the thickness of the wall:

$$\rho_2 = 0,75 \quad (5.3)$$

unless the eccentricity of the load at the top of the wall is greater than $0,25$ times the thickness of wall in which case

$$\rho_2 = 1,0 \quad (5.4)$$

(ii) For walls restrained at the top and bottom by timber floors or roofs spanning from both sides at the same level or by a timber floor spanning from one side having a bearing of at least $2/3$ the thickness of the wall but not less than 85 mm:

$$\rho_2 = 1,0 \quad (5.5)$$

(iii) For walls restrained at the top and bottom and stiffened on one vertical edge (with one free vertical edge):

— when $h \leq 3,5 l$,

$$\rho_3 = \frac{1}{1 + \left[\frac{\rho_2 h}{3 l} \right]^2} \rho_2 \quad (5.6)$$

with ρ_2 from (i) or (ii), whichever is appropriate, or

— when $h > 3,5 l$,

$$\rho_3 = \frac{1,5 l}{h} \geq 0,3 \quad (5.7)$$

where:

l is the length of the wall.

NOTE Values for ρ_3 are shown in graphical form in Annex D.

(iv) For walls restrained at the top and bottom and stiffened on two vertical edges:

— when $h \leq 1,15 l$, with ρ_2 from (i) or (ii), whichever is appropriate,

$$\rho_4 = \frac{1}{1 + \left[\frac{\rho_2 h}{l} \right]^2} \rho_2 \quad (5.8)$$

or

— when $h > 1,15 l$,

$$\rho_4 = \frac{0,5 l}{h} \quad (5.9)$$

where

l is the length of the wall.

NOTE Values for ρ_4 are shown in graphical form in Annex D.

5.5.1.3 Effective thickness of masonry walls

(1) The effective thickness, t_{ef} , of a single-leaf wall, a double-leaf wall, a faced wall, a shell bedded wall and a grouted cavity wall, as defined in 1.5.10, should be taken as the actual thickness of the wall, t .

(2) The effective thickness of a wall stiffened by piers should be obtained from equation (5.10):

$$t_{\text{ef}} = \rho_t t \quad (5.10)$$

where:

t_{ef} is the effective thickness;

ρ_t is a coefficient obtained from table 5.1;

t is the thickness of the wall.

Table 5.1 — Stiffness coefficient, ρ_p , for walls stiffened by piers, see figure 5.2

Ratio of pier spacing (centre to centre) to pier width	Ratio of $\frac{AC_1}{AC_2}$ pier depth $\frac{AC_1}{AC_2}$ to actual thickness of wall to which it is bonded		
	1	2	3
6	1,0	1,4	2,0
10	1,0	1,2	1,4
20	1,0	1,0	1,0

NOTE Linear interpolation between the values given in table 5.1 is permissible.

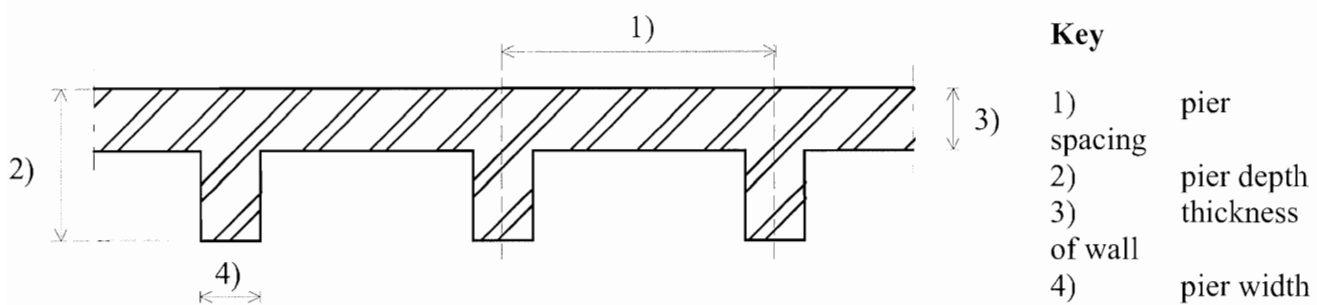

Figure 5.2 — Diagrammatic view of the definitions used in table 5.1

(3) The effective thickness, t_{ef} , of a cavity wall in which both leaves are connected with wall ties in accordance with 6.5 should be determined using equation (5.11):

$$t_{ef} = \sqrt[3]{k_{tef} t_1^3 + t_2^3} \quad (5.11)$$

where:

t_1, t_2 are the actual thicknesses of the leaves or their effective thicknesses, calculated from equation (5.10), when relevant, and t_1 is the thickness of the outer or unloaded leaf and t_2 is the thickness of the inner or loaded leaf;

k_{tef} is a factor to allow for the relative E values of the leaves t_1 and t_2 .

NOTE The value of k_{tef} to be used in a country may be found in its National Annex. The recommended value of k_{tef} (defined as E_1/E_2) should not be taken to be greater than 2

(4) When only one leaf of a cavity wall is loaded, equation (5.11) may be used to calculate the effective thickness, provided that the wall ties have sufficient flexibility such that the loaded leaf is not affected adversely by the unloaded leaf. In calculating the effective thickness, the thickness of the unloaded leaf should not be taken to be greater than the thickness of the loaded leaf.

5.5.1.4 Slenderness ratio of masonry walls

(1)P The slenderness ratio of a masonry wall shall be obtained by dividing the value of the effective height, h_{ef} , by the value of the effective thickness, t_{ef} .

(2) The slenderness ratio of the masonry wall should not be greater than 27 when subjected to mainly vertical loading.

5.5.2 Reinforced masonry members subjected to vertical loading

5.5.2.1 Slenderness ratio

(1) The slenderness ratio of vertically loaded reinforced masonry members in the plane of the member should be determined in accordance with 5.5.1.4

(2) When calculating the slenderness ratio of grouted cavity walls, the thickness of the wall should not be based on a cavity width greater than 100 mm.

(3) The slenderness ratio of the members should not be greater than 27.

5.5.2.2 Effective span of masonry beams

(1) The effective span, l_{ef} , of simply supported or continuous masonry beams, with the exception of deep beams, may be taken as the smaller of the following (see figure 5.3):

- the distance between centres of supports;
- the clear distance between supports plus the effective depth, d .

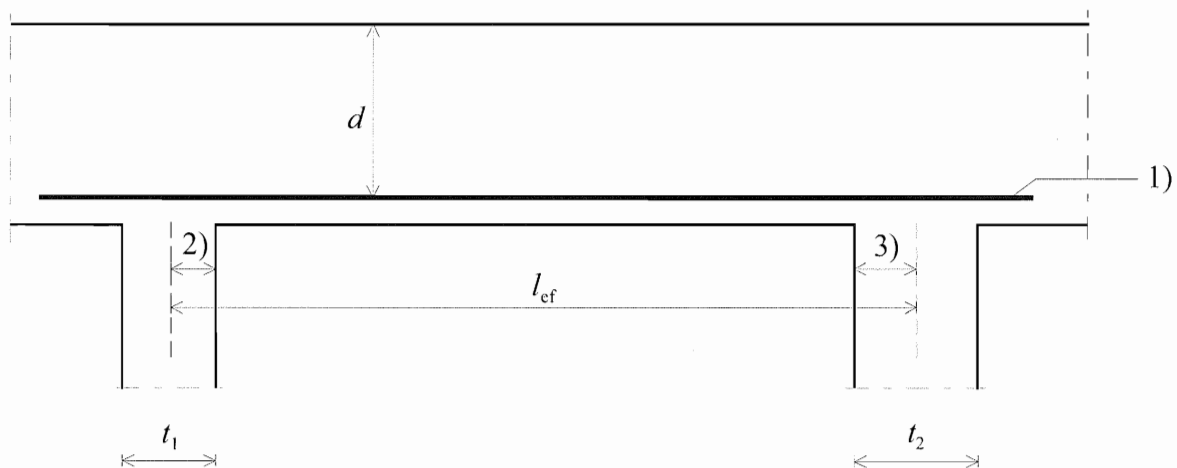

Key

- 1) reinforcement
- 2) $t_1/2$ or $d/2$ whichever is the smaller
- 3) $t_2/2$ or $d/2$ whichever is the smaller

Figure 5.3 — Effective span of simply supported or continuous masonry beams

(2) The effective span, l_{ef} , of a masonry cantilever may be taken as the smaller of the following (see figure 5.4):

- the distance between the end of the cantilever and the centre of its support;
- the distance between the end of the cantilever and the face of the support plus half its effective depth, d .

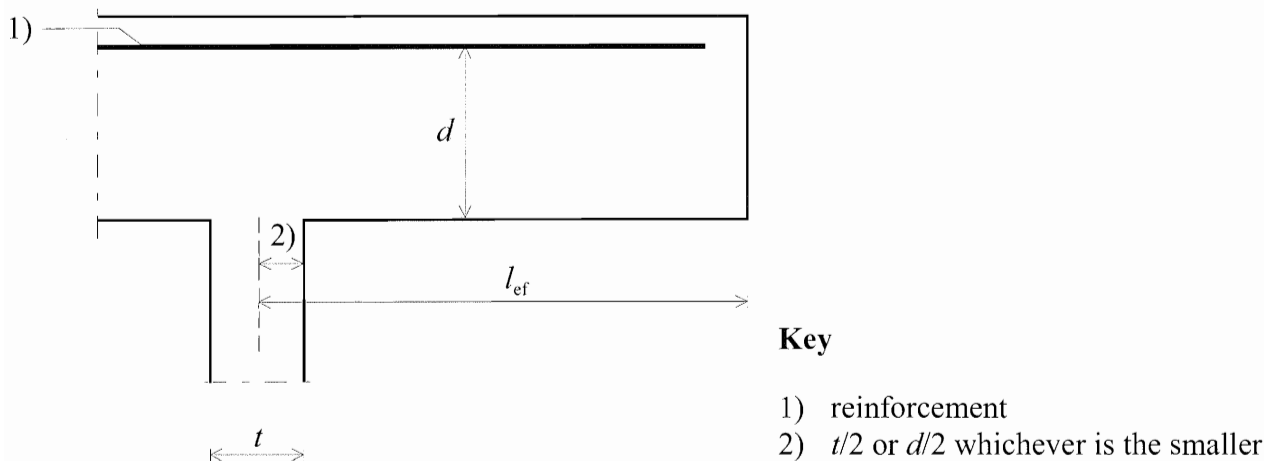

Figure 5.4 — Effective span of masonry cantilever

(3) The effective span of deep masonry beams may be determined according to 5.5.2.3.

5.5.2.3 Deep masonry beams subjected to vertical loading

(1) Deep masonry beams are vertically loaded walls, or parts of walls, bridging openings, such that the ratio of the overall height of the wall above the opening to the effective span of the opening is at least 0,5. The effective span of the deep beam may be taken as:

$$l_{ef} = 1,15 l_{cl} \quad (5.12)$$

where:

l_{cl} is the clear width of the opening, see figure 5.5.

(2) All the vertical loads acting on that part of the wall situated above the effective span should be taken into account, unless the loads can be taken by other means, for example, by upper floors acting as ties.

(3) In determining the bending moments, the deep beam may be considered as simply supported between supports as shown in figure 5.5.

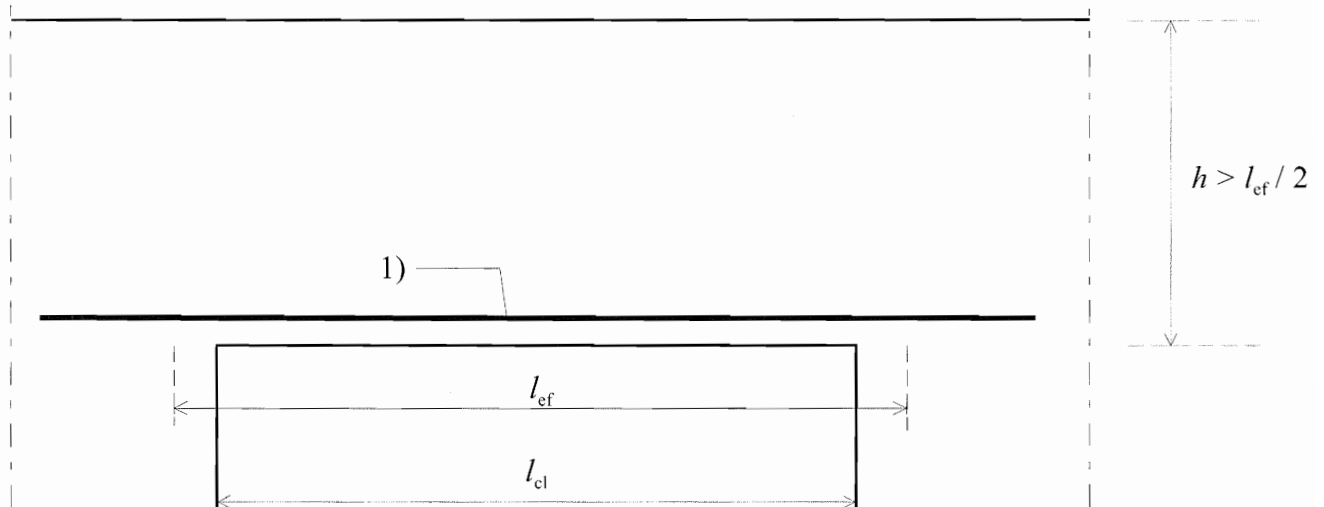

Key

- 1) reinforcement

Figure 5.5 — Analysis of a deep masonry beam

5.5.2.4 Redistribution of internal forces

(1) In reinforced masonry members, the linear elastic distribution of internal forces may be modified, assuming equilibrium, if the members have sufficient ductility, which can be assumed if the ratio of the depth of the neutral axis, x , to the effective depth, d , does not exceed 0,4 before redistribution of moments has been carried out. The influence on all aspects of a design from any redistribution of moments should be taken into account in accordance with EN 1992-1-1.

5.5.2.5 Limiting span of reinforced masonry members subjected to bending

(1) The span of reinforced masonry members should be limited to the appropriate value obtained from table 5.2.

Table 5.2 — Limiting ratios of effective span to effective depth for walls subjected to out-of-plane bending and beams

	Ratio of effective span to effective depth (l_{ef}/d) or effective thickness (l_{ef}/t_{ef})	
	Wall subjected to out-of-plane bending	Beam
Simply supported	35	20
Continuous	45	26
Spanning in two directions	45	-
Cantilever	18	7

NOTE For free-standing walls not forming part of a building and subjected predominantly to wind loads, the ratios may be increased by 30 %, provided such walls have no applied finish which may be damaged by deflections.

(2) In simply supported or continuous members, the clear distance between lateral restraints, l_r , should not exceed:

$$l_r \leq 60 b_c \text{ or} \tag{5.13}$$

$$l_r \leq \frac{250}{d} b_c^2, \text{ whichever is the lesser} \tag{5.14}$$

where:

d is the effective depth of the member;

b_c is the width of the compression face midway between restraints.

(3) For a cantilever with lateral restraint provided only at the support, the clear distance from the end of the cantilever to the face of the support, l_r , should not exceed:

$$l_r \leq 25 b_c \text{ or} \tag{5.15}$$

$$l_r \leq \frac{100}{d} b_c^2 \text{ whichever is the lesser;} \tag{5.16}$$

where:

b_c is taken at the face of the support.

5.5.3 Masonry shear walls subjected to shear loading

(1) When analysing masonry walls subjected to shear loading, the elastic stiffness of the walls, including any flanges, should be used as the stiffness of the wall. For walls higher than twice their length, the effect of shear deformations on the stiffness can be neglected.

(2) An intersecting wall, or a portion of such a wall, may be considered to act as a flange to a shear wall provided that the connection of the shear wall to the flange is able to resist the corresponding shearing actions, and provided the flange will not buckle within the length assumed.

(3) The length of any intersecting wall, which may be considered to act as a flange (see figure 5.6), is the thickness of the shear wall plus, on each side of it - where appropriate - the least of:

- $h_{\text{tot}}/5$, where h_{tot} is the overall height of the shear wall;
- half the distance between shear walls (l_s), when connected by the intersecting wall;
- the distance to the end of the wall;
- half the clear height (h);
- six times the thickness of the intersecting wall, t .

(4) In intersecting walls, openings with dimensions smaller than $h/4$ or $l/4$ may be disregarded. Openings with dimensions greater than $h/4$ or $l/4$ should be regarded as marking the end of the wall.

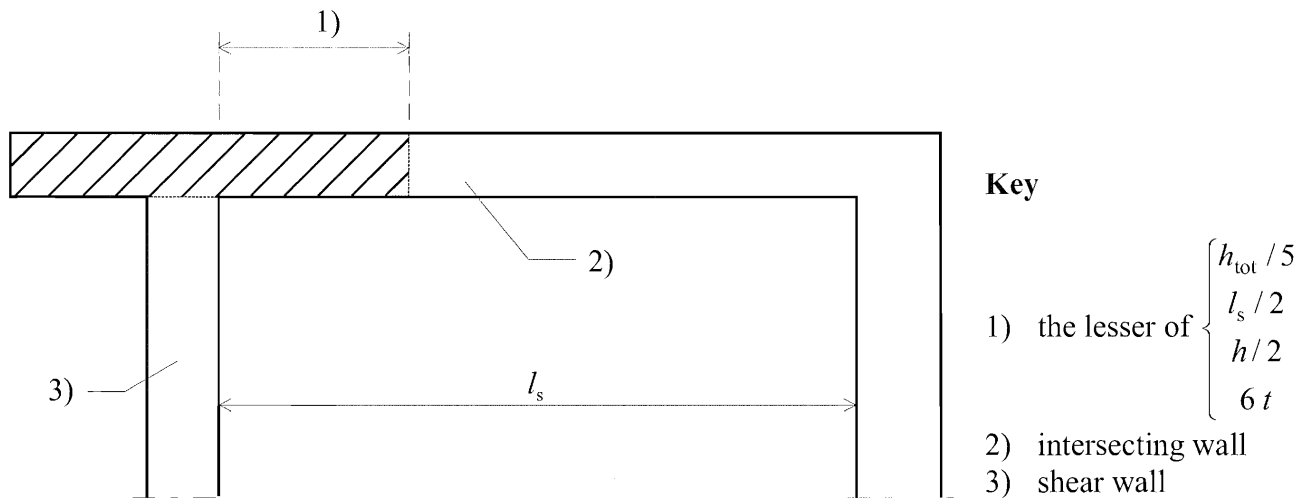

Figure 5.6 — Flange widths that can be assumed for shear walls

(5) If the floors can be idealised as rigid diaphragms, the horizontal forces may be distributed to the shear walls in proportion to their stiffness.

(6)P Where the plan arrangement of the shear walls is asymmetric, or for any other reason the horizontal force is eccentric to the overall stiffness centre of the structure, account shall be taken of the effect of the consequent rotation on the individual walls (torsional effects).

(7) If the floors are not sufficiently rigid when considered as horizontal diaphragms (for example, precast concrete units which are not inter-connected) horizontal forces to be resisted by the shear walls should be taken to be the forces from the floors to which they are directly connected, unless a semi rigid analysis is carried out.

(8) The maximum horizontal load on a shear wall may be reduced by up to 15 % provided that the load on the parallel shear walls is correspondingly increased.

(9) When deriving the relevant design load that assists shear resistance, the vertical load applied to slabs spanning in two directions may be distributed equally onto the supporting walls; in the case of floor or roof slabs spanning one way, a 45° spread of the load may be considered in deriving the axial load, at the lower storeys, on the walls not directly loaded.

(10) The distribution of shear stress along the compressed part of a wall may be assumed to be constant.

5.5.4 Reinforced masonry members subjected to shear loading

(1) In calculating the design shear load in reinforced masonry members with uniformly distributed loading, it may be assumed that the maximum shear load occurs at a distance $d/2$ from the face of a support, where d is the effective depth of the member.

(2) When taking the maximum shear load at $d/2$ from the face of a support, the following conditions should be satisfied:

- the loading and support reactions are such that they cause diagonal compression in the member (direct support);
- at an end support, the tension reinforcement required at a distance $2,5 d$ from the face of the support is anchored into the support;
- at an intermediate support, the tension reinforcement required at the face of the support extends for a distance at least $2,5 d$, plus the anchorage length, into the span.

5.5.5 Masonry walls subjected to lateral loading

(1) When analysing masonry walls subjected to lateral loading, allowance should be made in the design for the following:

- the effect of damp proof courses;
- support conditions and continuity over supports.

(2) A faced wall should be analysed as a single-leaf wall constructed entirely of the units giving the lower flexural strength.

(3) A movement joint in a wall should be treated as an edge across which moment and shear may not be transmitted.

NOTE Some specialised anchors are designed to transmit moment and/or shear across a movement joint; their use is not covered in this standard.

(4) The reaction along an edge of a wall due to the load may be assumed to be uniformly distributed when designing the means of support. Restraint at a support may be provided by ties, by bonded masonry returns or by floors or roofs.

(5) Where laterally loaded walls are bonded (see 8.1.4) to vertically loaded walls, or where reinforced concrete floors bear onto them, the support may be considered as being continuous. A damp-proof course should be considered as providing simple support. Where walls are connected to a vertically load bearing wall or other suitable structure by ties at the vertical edges, partial moment continuity at the vertical sides of the wall may be assumed, if the strength of the ties is verified to be sufficient.

(6) In the case of cavity walls, full continuity may be assumed even if only one leaf is continuously bonded across a support, provided that the cavity wall has ties in accordance with 6.3.3. The load to be transmitted from a wall to its support may be taken by ties to one leaf only, provided that there is adequate connection between the two leaves (see 6.3.3) particularly at the vertical edges of the walls. In all other cases, partial continuity may be assumed.

(7) When the wall is supported along 3 or 4 edges, the calculation of the applied moment, M_{Edi} , may be taken as:

— when the plane of failure is parallel to the bed joints, i. e. in the f_{xk1} direction:

$$M_{Ed1} = \alpha_1 W_{Ed} l^2 \text{ per unit length of the wall} \quad (5.17)$$

or,

— when the plane of failure is perpendicular to the bed joints, i. e. in the f_{xk2} direction:

$$M_{Ed2} = \alpha_2 W_{Ed} l^2 \text{ per unit height of the wall} \quad (5.18)$$

where:

α_1, α_2 are bending moment coefficients taking account of the degree of fixity at the edges of the walls, the height to length ratio of the walls; they can be obtained from a suitable theory;

l is the length of the wall;

W_{Ed} is the design lateral load per unit area.

NOTE Values of the bending coefficient α_1 and α_2 may be obtained from Annex E for single leaf walls with a thickness less than or equal to 250 mm, where $\alpha_1 = \mu \alpha_2$

where:

μ is the orthogonal ratio of the design flexural strengths of the masonry, f_{xd1}/f_{xd2} , see 3.6.3 or $f_{xd1,app}/f_{xd2}$, see **AC1** 6.3.1(4) **AC1** or $f_{xd1}/f_{xd2,app}$, see **AC1** 6.6.2(9) **AC1**;

(8) The bending moment coefficient at a damp proof course may be taken as for an edge over which full continuity exists when the design vertical stress on the damp proof course equals or exceeds the design tensile stress caused by the moment arising due to the action.

(9) When the wall is supported only along its bottom and top edges, the applied moment may be calculated from normal engineering principles, taking into account any continuity.

AC1(10) In a laterally loaded panel or free standing wall built of masonry set in mortar designations M2 to M20, and designed in accordance with 6.3, the dimensions should be limited to avoid undue movements resulting from deflections, creep, shrinkage, temperature effects and cracking.

NOTE The limiting values may be obtained from Annex F. **AC1**

(11) When irregular shapes of walls, or those with substantial openings, are to be designed, an analysis, using a recognized method of obtaining bending moments in flat plates, for example, finite element method or yield line analogy may be used, taking into account the anisotropy of masonry when appropriate.

Section 6 Ultimate Limit State

6.1 Unreinforced masonry walls subjected to mainly vertical loading

6.1.1 General

(1)P The resistance of masonry walls to vertical loading shall be based on the geometry of the wall, the effect of the applied eccentricities and the material properties of the masonry.

(2) In calculating the vertical resistance of masonry walls, it may be assumed that:

- plane sections remain plane;
- the tensile strength of masonry perpendicular to bed joints is zero.

6.1.2 Verification of unreinforced masonry walls subjected to mainly vertical loading

6.1.2.1 General

(1)P At the ultimate limit state, the design value of the vertical load applied to a masonry wall, N_{Ed} , shall be less than or equal to the design value of the vertical resistance of the wall, N_{Rd} , such that:

$$N_{Ed} \leq N_{Rd} \quad (6.1)$$

(2) The design value of the vertical resistance of a single leaf wall per unit length, N_{Rd} , is given by:

$$N_{Rd} = \Phi t f_d \quad (6.2)$$

where:

- Φ is the capacity reduction factor, Φ_t , at the top or bottom of the wall, or Φ_m , in the middle of the wall, as appropriate, allowing for the effects of slenderness and eccentricity of loading, obtained from 6.1.2.2;
- t is the thickness of the wall;
- f_d is the design compressive strength of the masonry, obtained from 2.4.1 and 3.6.1.

(3) Where the cross-sectional area of a wall is less than 0,1 m², the design compressive strength of the masonry, f_d , should be multiplied by the factor:

$$(0,7 + 3 A) \quad (6.3)$$

where:

A is the loaded horizontal gross cross-sectional area of the wall, expressed in square metres.

(4) For cavity walls, each leaf should be verified separately, using the plan area of the loaded leaf and the slenderness ratio based upon the effective thickness of the cavity wall, calculated according to equation (5.11).

(5) A faced wall, should be designed in the same manner as a single-leaf wall constructed entirely of the weaker units, using the value of K , from table 3.3, appropriate to a wall with a longitudinal mortar joint.

(6) A double-leaf wall, tied together according to clause 6.5 may be designed as a single-leaf wall, if both leaves have a load of similar magnitude, or, alternatively, as a cavity wall.

(7) When chases or recesses are outside the limits given in clause 8.6, the effect on loadbearing capacity should be taken into account as follows:

- vertical chases or recesses should be treated either as a wall end or, alternatively, the residual thickness of the wall should be used in the calculations of the design vertical load resistance;
- horizontal or inclined chases should be treated by verifying the strength of the wall at the chase position, taking account of the load eccentricity.

NOTE As a general guide the reduction in vertical loadbearing capacity may be taken to be proportional to the reduction in cross-sectional area due to any vertical chase or recess, provided that the reduction in area does not exceed 25 %.

6.1.2.2 Reduction factor for slenderness and eccentricity

(1) The value of the reduction factor for slenderness and eccentricity, Φ , may be based on a rectangular stress block as follows:

(i) At the top or bottom of the wall (Φ_i)

$$\Phi_i = 1 - 2 \frac{e_i}{t} \quad (6.4)$$

where:

e_i is the eccentricity at the top or the bottom of the wall, as appropriate, calculated using the equation (6.5):

$$e_i = \frac{M_{id}}{N_{id}} + e_{he} + e_{init} \geq 0,05 t \quad (6.5)$$

M_{1d} is the design value of the bending moment at the top or the bottom of the wall resulting from the eccentricity of the floor load at the support, analysed according to 5.5.1 (see figure 6.1);

N_{1d} is the design value of the vertical load at the top or bottom of the wall;

e_{hc} is the eccentricity at the top or bottom of the wall, if any, resulting from horizontal loads (for example, wind);

e_{init} is the initial eccentricity with a sign that increases the absolute value of e_i (see 5.5.1.1);

t is the thickness of the wall.

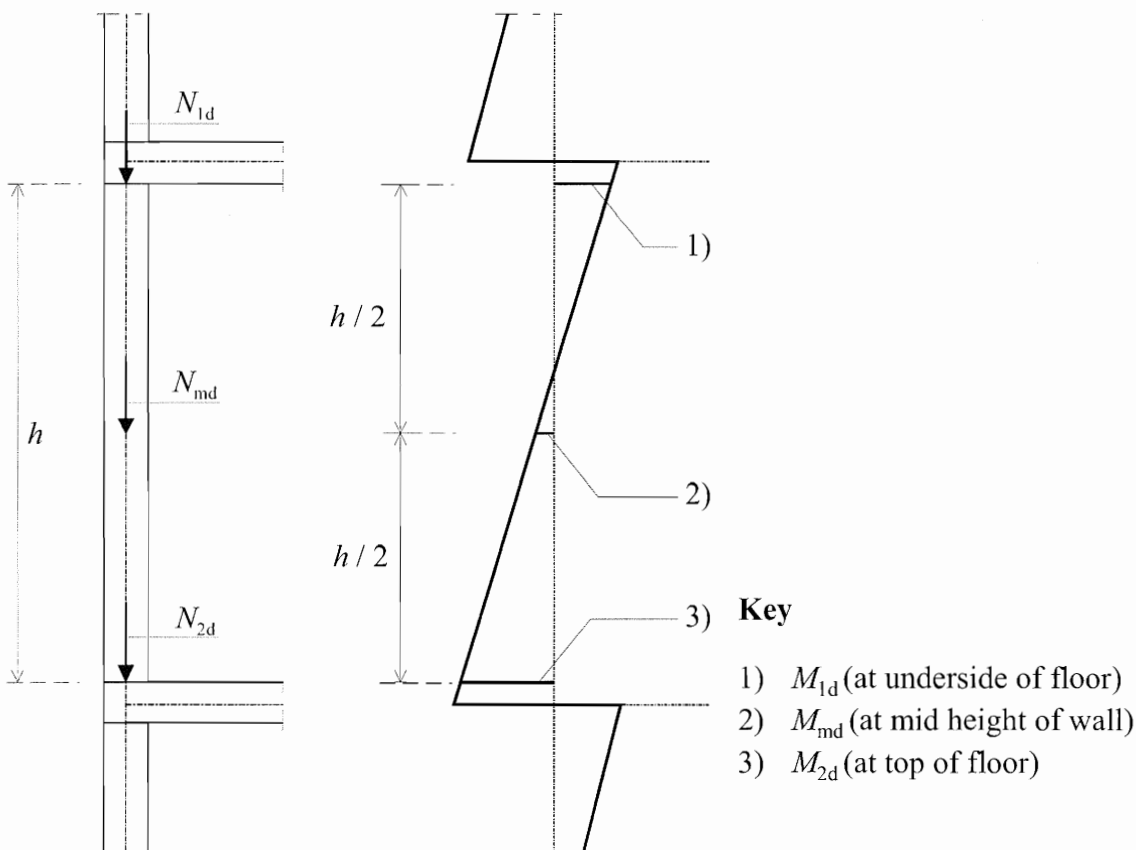

Figure 6.1 — Moments from calculation of eccentricities

(ii) In the middle of the wall height (Φ_m)

By using a simplification of the general principles given in 6.1.1, the reduction factor within the middle height of the wall Φ_m , may be determined using e_{mk} , where:

e_{mk} is the eccentricity at the middle height of the wall, calculated using equations (6.6) and (6.7):

$$e_{mk} = e_m + e_k \geq 0,05 t \quad (6.6)$$

$$\boxed{\text{AC1}} e_m = \frac{M_{\text{md}}}{N_{\text{md}}} + e_{\text{hm}} + e_{\text{init}} \quad (6.7) \boxed{\text{AC1}}$$

e_m is the eccentricity due to loads;

M_{md} is the design value of the greatest moment at the middle of the height of the wall resulting from the moments at the top and bottom of the wall (see figure 6.1), including any load applied eccentrically to the face of the wall (e. g. brackets);

N_{md} is the design value of the vertical load at the middle height of the wall, including any load applied eccentrically to the face of the wall (e. g. brackets);

e_{hm} is the eccentricity at mid-height resulting from horizontal loads (for example, wind);

NOTE The inclusion of e_{hm} depends on the load combination being used for the verification; its sign relative to that of $M_{\text{md}}/N_{\text{md}}$ should be taken into account.

$\boxed{\text{AC1}} e_{\text{init}}$ is the initial eccentricity with a sign that increases the absolute value of e_m (see 5.5.1.1); $\boxed{\text{AC1}}$

h_{cf} is the effective height, obtained from 5.5.1.2 or the appropriate restraint or stiffening condition;

t_{cf} is the effective thickness of the wall, obtained from 5.5.1.3;

e_k is the eccentricity due to creep, calculated from the equation (6.8):

$$e_k = 0,002 \phi_{\infty} \frac{h_{\text{cf}}}{t_{\text{cf}}} \sqrt{t e_m} \quad (6.8)$$

ϕ_{∞} is the final creep coefficient (see note under 3.7.4(2))

$\boxed{\text{AC1}}$ NOTE ϕ_m , may be determined from Annex G, using e_{mk} as expressed above. $\boxed{\text{AC1}}$

(2) For walls having a slenderness ratio of λ_c or less, the creep eccentricity, e_k may be taken as zero.

NOTE The value of λ_c to be used in a country may be found in its National Annex, the recommended value of λ_c is 15. The country can make a distinction for different types of masonry related to the national choices made on the final creep coefficient.

6.1.3 Walls subjected to concentrated loads

(1)P The design value of a concentrated vertical load, N_{Edc} , applied to a masonry wall, shall be less than or equal to the design value of the vertical concentrated load resistance of the wall, N_{Rdc} , such that

$$N_{\text{Edc}} \leq N_{\text{Rdc}} \quad (6.9)$$

(2) When a wall, built with Group 1 masonry units and detailed in accordance with section 8, other than a shell bedded wall, is subjected to a concentrated load, the design value of the vertical load resistance of the wall is given by:

$$N_{Rdc} = \beta A_b f_d \quad (6.10)$$

where:

$$\beta = \left(1 + 0,3 \frac{a_1}{h_c} \right) \left(1,5 - 1,1 \frac{A_b}{A_{cf}} \right) \quad (6.11)$$

which should not be less than 1,0 nor taken to be greater than:

$$1,25 + \frac{a_1}{2 h_c} \text{ or } 1,5 \text{ whichever is the lesser}$$

where:

- β is an enhancement factor for concentrated loads;
- a_1 is the distance from the end of the wall to the nearer edge of the loaded area (see figure 6.2);
- h_c is the height of the wall to the level of the load;
- A_b is the loaded area;
- A_{cf} is the effective area of bearing, i. e. $l_{cfm} \cdot t$;
- l_{cfm} is the effective length of the bearing as determined at the mid height of the wall or pier (see figure 6.2);
- t is the thickness of the wall, taking into account the depth of recesses in joints greater than 5 mm;
- $\frac{A_b}{A_{cf}}$ is not to be taken greater as 0,45.

NOTE Values for the enhancement factor for β are shown in graphical form in Annex H.

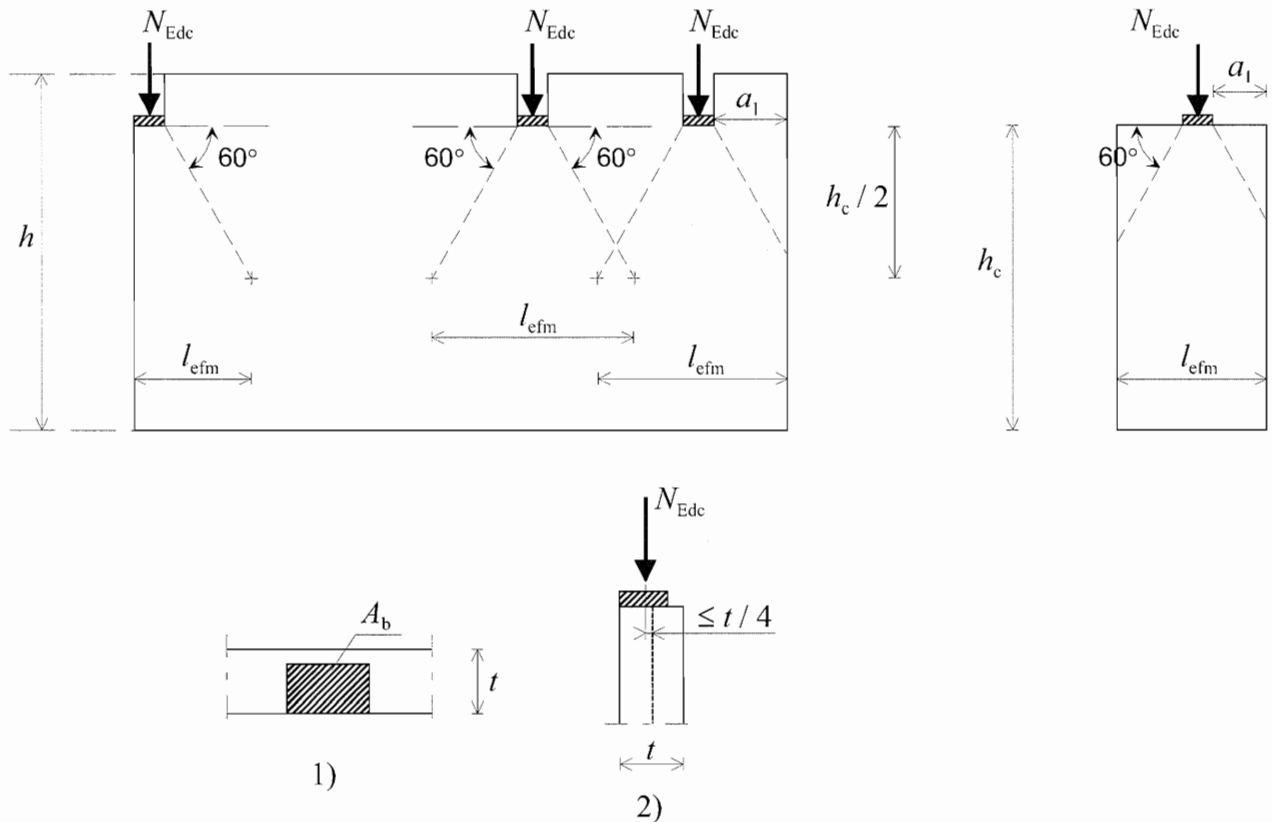
**Key**

- 1) plan
- 2) section

Figure 6.2 — Walls subjected to concentrated load

(3) For walls built with Groups 2, 3 and Group 4 masonry units and when shell bedding is used, it should be verified that, locally under the bearing of a concentrated load, the design compressive stress does not exceed the design compressive strength of masonry, f_d (i.e. β is taken to be $\frac{AC_1}{AC_1} \cdot 1,0$).

(4) The eccentricity of the load from the centre line of the wall should not be greater than $t/4$ (see figure 6.2).

(5) In all cases, the requirements of 6.1.2.1 should be met at the middle height of the wall below the bearings, including the effects of any other superimposed vertical loading, particularly for the case where concentrated loads are sufficiently close together for their effective lengths to overlap.

(6) The concentrated load should bear on a Group 1 unit or other solid material of length equal to the required bearing length plus a length on each side of the bearing based on a 60° spread of load to the base of the solid material; for an end bearing the additional length is required on one side only.

(7) Where the concentrated load is applied through a spreader beam of adequate stiffness and of width equal the thickness of the wall, height greater than 200 mm and length greater than three times the bearing length of the load, the design value of the compressive stress beneath the concentrated load should not exceed $1,5 f_d$.

6.2 Unreinforced masonry walls subjected to shear loading

(1)P At the ultimate limit state the design value of the shear load applied to the masonry wall, V_{Ed} , shall be less than or equal to the design value of the shear resistance of the wall, V_{Rd} , such that :

$$V_{Ed} \leq V_{Rd} \quad (6.12)$$

(2) The design value of the shear resistance is given by:

$$V_{Rd} = f_{vd} t l_c \quad (6.13)$$

where:

f_{vd} is the design value of the shear strength of masonry, obtained from 2.4.1 and 3.6.2, based on the average of the vertical stresses over the compressed part of the wall that is providing the shear resistance;

t is the thickness of the wall resisting the shear;

l_c is the length of the compressed part of the wall, ignoring any part of the wall that is in tension.

(3) The length of the compressed part of the wall, l_c , should be calculated assuming a linear stress distribution of the compressive stresses, and taking into account any openings, chases or recesses; any portion of the wall subjected to vertical tensile stresses should not be used in calculating the area of the wall to resist shear.

(4)P The connections between shear walls and flanges of intersecting walls shall be verified for vertical shear.

(5) The length of the compressed part of the wall should be verified for the vertical loading applied to it and the vertical load effect of the shear loads.

6.3 Unreinforced masonry walls subjected to lateral loading

6.3.1 General

(1)P At the ultimate limit state, the design value of the moment applied to the masonry wall, M_{Ed} (see 5.5.5), shall be less than or equal to the design value of the moment of resistance of the wall, M_{Rd} , such that:

$$M_{Ed} \leq M_{Rd} \quad (6.14)$$

(2) The orthogonal strength ratio, μ , of the masonry should be taken into account in the design.

(3) The design value of the lateral moment of resistance of a masonry wall, M_{Rd} , per unit height or length, is given by:

$$M_{Rd} = f_{xd} Z \quad (6.15)$$

where:

f_{xd} is the design flexural strength appropriate to the plane of bending, obtained from 3.6.3, 6.3.1(4) or 6.6.2 (9);

Z is the elastic section modulus of unit height or length of the wall.

(4) When a vertical load is present, the favourable effect of the vertical stress may be taken into account either by:

(i) using the apparent flexural strength, $f_{xd1,app}$, given by equation (6.16), the orthogonal ratio used in (2) above being modified accordingly.

$$f_{xd1,app} = f_{xd1} + \sigma_d \quad (6.16)$$

where:

f_{xd1} is the design flexural strength of masonry with the plane of failure parallel to the bed joints, see 3.6.3;

σ_d is the design compressive stress on the wall, not taken to be greater than $0,2 f_d$

or

(ii) by calculating the resistance of the wall using formula (6.2) in which Φ is replaced by Φ_{fl} , taking into account the flexural strength, f_{xd1} .

NOTE This Part does not include a method of calculating ϕ_{fl} including flexural strength.

(5) In assessing the section modulus of a pier in a wall, the outstanding length of flange from the face of the pier should be taken as the lesser of:

- $h/10$ for walls spanning vertically between restraints;
- $h/5$ for cantilever walls;
- half the clear distance between piers;

where:

h is the clear height of the wall.

(6) In a cavity wall, the design lateral load per unit area, W_{Ed} , may be apportioned between the two leaves provided that the wall ties, or other connectors between the leaves, are capable of transmitting the actions to which the cavity wall is subjected. The apportionment between the two leaves may be in proportion either to their strength (i. e. using M_{Rd}), or the stiffness of each leaf. When using the stiffness, each leaf should then be verified for its proportion of M_{Ed} .

(7) If a wall is weakened by chases or recesses outside the limits given in clause 8.6, this weakening should be taken into account when determining the load bearing capacity by using the reduced thickness of the wall at the chase or recess position.

6.3.2 Walls arching between supports

(1)P At the ultimate limit state, the design lateral load effect due to arch action in a wall shall be less than or equal to the design load resistance under an arch action and the design strength of the supports for the arch shall be greater than the effect of the design lateral load.

(2) A masonry wall built solidly between supports capable of resisting an arch thrust may be designed assuming that a horizontal or vertical arch develops within the thickness of the wall.

(3) Analysis may be based on a three-pin arch, when the bearing of the arch thrust at the supports and at the central hinge should be assumed as 0,1 times the thickness of the wall, as indicated on figure 6.3. If chases or recesses occur near the thrust-lines of the arch, their effect on the strength of the masonry should be taken into account.

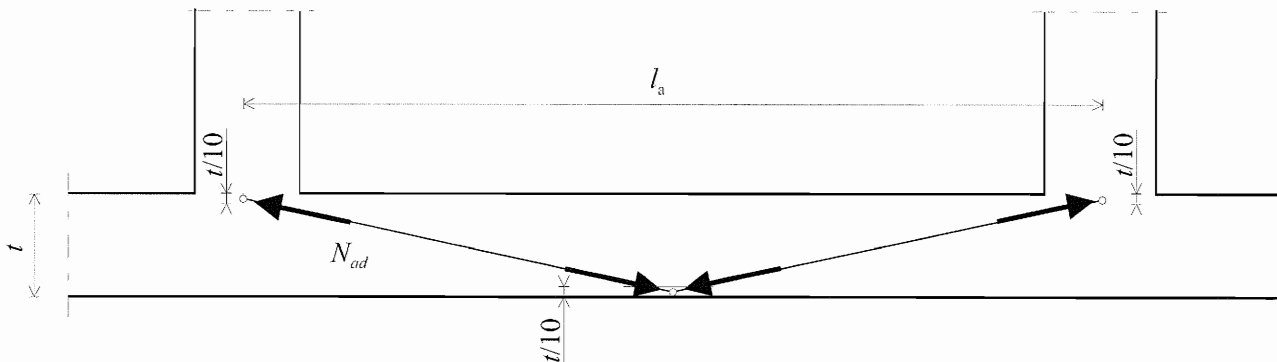

Figure 6.3 — Arch assumed for resisting lateral loads (diagrammatic)

(4) The arch thrust should be assessed from knowledge of the applied lateral load, the strength of the masonry in compression, the effectiveness of the junction between the wall and the support resisting the thrust and the elastic and time dependent shortening of the wall. The arch thrust may be provided by a vertical load.

(5) The arch rise, r , is given by equation (6.17):

$$r = 0,9 t - d_a \quad (6.17)$$

where:

- t is the thickness of the wall, taking into account the reduction in thickness resulting from recessed joints;
- d_a is the deflection of the arch under the design lateral load; it may be taken to be zero for walls having a length to thickness ratio of 25 or less.

(6) The maximum design arch thrust per unit length of wall, N_{ad} , may be obtained from equation (6.18):

$$N_{ad} = 1,5 f_d \frac{t}{10} \quad (6.18)$$

and where the lateral deflection is small, the design lateral strength is given by:

$$q_{lat,d} = f_d \left(\frac{t}{l_a} \right)^2 \quad (6.19)$$

where:

N_{ad} is the design arch thrust;

$q_{lat,d}$ is the design lateral strength per unit area of wall;

t is the thickness of the wall;

f_d is the design compressive strength of the masonry in the direction of the arch thrust, obtained from clause 3.6.1;

l_a is the length or the height of the wall between supports capable of resisting the arch thrust

provided that:

- any damp proof course or other plane of low frictional resistance in the wall can transmit the relevant horizontal forces;
- the design value of the stress due to vertical load is not less than 0,1 N/mm²;
- the slenderness ratio $\langle \overline{AC_1} \rangle$ in the considered direction $\langle \overline{AC_1} \rangle$ does not exceed 20.

6.3.3 Walls subjected to wind loading

(1) Walls subjected to wind loading should be designed using 5.5.5, 6.3.1 and 6.3.2, as relevant.

6.3.4 Walls subjected to lateral loading from earth and water

(1) Walls subject to lateral earth pressure with/or without vertical loads, should be designed using 5.5.5, 6.1.2, 6.3.1 and 6.3.2, as relevant.

NOTE 1 The flexural strength of masonry f_{xk1} should not be used in the design of walls subjected to lateral earth pressure.

NOTE 2 A simplified method for designing basement walls subjected to lateral earth pressure is given in EN 1996-3.

6.3.5 Walls subjected to lateral loading from accidental situations

(1) Walls subjected to horizontal accidental loads, other than those resulting from seismic actions (for example, gas explosions), may be designed in accordance with 5.5.5, 6.1.2, 6.3.1, and 6.3.2, as relevant.

6.4 Unreinforced masonry walls subjected to combined vertical and lateral loading

6.4.1 General

(1) Unreinforced masonry walls that are subjected to both vertical and lateral loading may be verified by using any one of the methods given in 6.4.2, 6.4.3 or 6.4.4, as appropriate.

6.4.2 Method using Φ factor

(1) By using the relevant value of the eccentricity due to horizontal actions, $\sqrt{AC_1} e_{hc}$ or e_{hm} , according to 6.1.2.2(1) (i) or (ii), a slenderness reduction factor, Φ , that takes into account the combined vertical and horizontal loading, can be obtained, using equations (6.5) and (6.7), for use in equation (6.2).

6.4.3 Method using apparent flexural strength

(1) 6.3.1 allows the design flexural strength of masonry, f_{xd1} , to be increased by the permanent vertical load to an apparent flexural strength, $f_{xd1,app}$, for use with the verification given in that part.

6.4.4 Method using equivalent bending moment coefficients

(1) Equivalent bending moments may be obtained from a combination of 6.4.2 and 6.4.3, to allow a combined calculation of vertical and horizontal loading.

NOTE Annex I gives a method of modifying the bending moment coefficient, α , as described in 5.5.5, to allow for both vertical and horizontal loads.

6.5 Ties

(1)P For calculation of the structural resistance of ties, the combination of the following shall be taken into account:

- differential movement between the connected structural members, typically faced wall and backing leaf, e. g. due to temperature differences, changes of moisture and actions;
- horizontal wind action;
- force due to interaction of leaves in cavity walls.

(2)P In determining the structural resistance of the ties, account shall be taken of any deviations from straightness and to any impairment of the material including the risk of brittle failure due to the successive deformations to which they are subjected during and after the execution.

(3)P Where walls, especially cavity walls and veneer walls are subjected to lateral wind loads, the wall ties connecting the two leaves shall be capable of distributing the wind loads from the loaded leaf to the other leaf, backing wall or support.

(4) The minimum number of wall ties per unit area, n_t , should be obtained from equation (6.20):

$$n_t \geq \frac{W_{Ed}}{F_d} \quad (6.20)$$

but not less than according to 8.5.2.2.

where:

W_{Ed} is the $\langle AC_1 \rangle$ design value of the horizontal load, per unit area, to be transferred;

F_d is the design compressive or tensile resistance of a wall tie, as appropriate to the design condition.

NOTE 1 EN 845-1 requires that a manufacturer declares the strength of the ties; the declared value should be divided by γ_M to obtain the design value.

NOTE 2 The selection of wall ties should allow differential movement to take place between the leaves, without causing damage.

(5) In the case of a veneer wall, W_{Ed} , should be calculated on the basis that the wall ties are required to transmit all of the design horizontal wind load acting on the veneer wall to the backing structure.

6.6 Reinforced masonry members subjected to bending, bending and axial loading, or axial loading

6.6.1 General

(1)P The design of reinforced masonry members subjected to bending, bending and axial loading, or axial loading, shall be based on the following assumptions:

- plane sections remain plane;
- the reinforcement is subjected to the same variations in strain as the adjacent masonry;
- the tensile strength of the masonry is taken to be zero;
- the maximum compressive strain of the masonry is chosen according to the material;
- the maximum tensile strain in the reinforcement is chosen according to the material;
- the stress-strain relationship of masonry is taken to be linear, parabolic, parabolic rectangular or rectangular (see 3.7.1);
- the stress-strain relationship of the reinforcement is obtained from EN 1992-1-1;
- for cross-sections not fully in compression, the limiting compressive strain is taken to be not greater than $\varepsilon_{mu} = -0,0035$ for Group 1 units and $\varepsilon_{mu} = -0,002$ for Group 2, 3 and 4 units (see figure 3.2).

(2)P The deformation properties of concrete infill shall be assumed to be as for masonry.

(3) The design compressive stress block for masonry or concrete infill may be based on figure 3.2, where f_d is the design compressive strength of masonry, in the direction of loading, or concrete infill.

(4) When a compression zone contains both masonry and concrete infill, the compressive strength should be calculated using a stress block based on the compressive strength of the weakest material.

6.6.2 Verification of reinforced masonry members subjected to bending and/or axial loading

(1)P At the ultimate limit state, the design value of the load applied to a reinforced masonry member, E_d , shall be less than or equal to the design load resistance of the member, R_d , such that:

$$\boxed{\text{AC1}} E_d \leq R_d \quad (6.21) \quad \boxed{\text{AC1}}$$

(2) The design resistance of the member should be based on the assumptions described in 6.6.1. The tensile strain of the reinforcement ε_s should be limited to 0,01.

(3) In determining the design value of the moment of resistance of a section, a rectangular stress distribution as indicated in figure 6.4 may be assumed as a simplification.

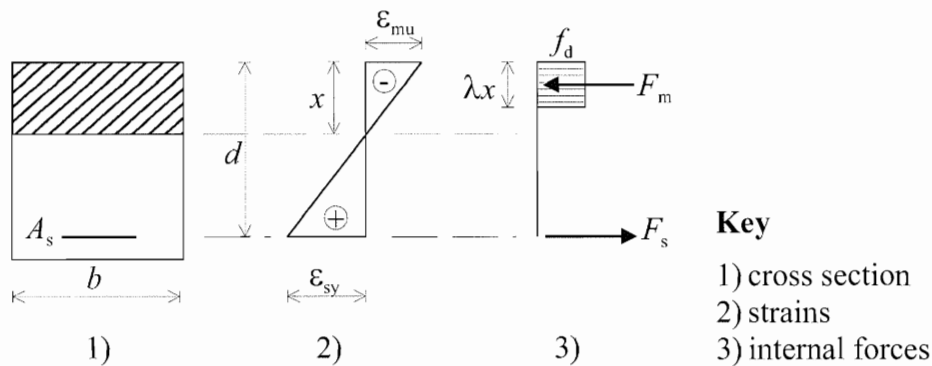

Figure 6.4 — Stress and strain distribution

(4) For the case of a singly reinforced rectangular cross-section, subject to bending only, the design value of the moment of resistance, M_{Rd} , may be taken as :

$$M_{Rd} = A_s f_{yd} z \quad (6.22)$$

where, based on the simplification illustrated in figure 6.4, the lever arm, z , may be taken, for a section when the maximum compression and tension are reached together, as:

$$z = d \left(1 - 0,5 \frac{A_s f_{yd}}{b d f_d} \right) \leq 0,95 d \quad (6.23)$$

where:

b is the width of the section;

d is the effective depth of the section;

A_s is the cross-sectional area of the reinforcement in tension;

f_d is the design compressive strength of masonry in the direction of loading, obtained from 2.4.1 and 3.6.1, or concrete infill, obtained from 2.4.1 and 3.3, whichever is the lesser;

f_{yd} is the design strength of reinforcing steel.

NOTE For the special case of reinforced masonry cantilever walls subjected to bending, refer to (5), below.

(5) In determining the design value of the moment of resistance, M_{Rd} , of reinforced masonry members subject to bending, the design compressive strength, f_d , in figure 6.4, may be taken over the depth from the compressed edge of the cross-section, λx , when the design value of the moment of resistance, M_{Rd} , in compression, should not be taken to be greater than:

$$\boxed{AC1} M_{Rd} \leq 0,4 f_d b d^2 \boxed{AC1} \text{ for Group 1 units other than lightweight aggregate units} \quad (6.24a)$$

and

$$\boxed{AC1} M_{Rd} \leq 0,3 f_d b d^2 \boxed{AC1} \text{ for Group 2, 3 and 4 and Group 1 lightweight aggregate units.} \quad (6.24b)$$

where:

f_d is the design compressive strength of masonry;

b is the width of the section;

d is the effective depth of the section; and

x is the depth to the neutral axis.

(6) When the reinforcement in a section is concentrated locally such that the member cannot be treated as a flanged member (see 6.6.3), the reinforced section should be considered as having a width of not more than 3 times the thickness of the masonry (see figure 6.5).

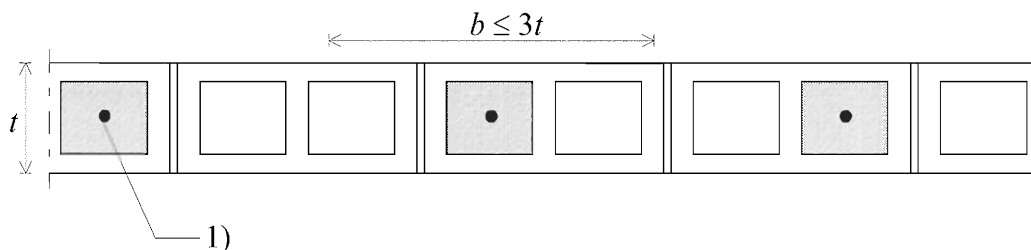

Key

1 reinforcement

Figure 6.5 — Width of section for members with locally concentrated reinforcement

(7) Reinforced masonry members with a slenderness ratio, calculated in accordance with 5.5.1.4, greater than 12, may be designed using the principles and application rules for unreinforced members in 6.1, taking into account second order effects by an additional design moment, M_{ad} :

$$M_{ad} = \frac{N_{Ed} h_{ef}^2}{2000 \cdot t} \quad (6.25)$$

where:

- N_{Ed} is the design value of the vertical load;
- h_{ef} is the effective height of the wall;
- t is the thickness of the wall.

(8) Reinforced masonry members subjected to a small axial force may be designed for bending, only, if the design axial stress, σ_d , does not exceed:

$$\sigma_d \leq 0,3 f_d \quad (6.26)$$

where:

- f_d is the design compressive strength of masonry.

(9) In walls reinforced with prefabricated bed joint reinforcement to assist their resistance to lateral loads, when the strength of such reinforcement is needed to arrive at a bending moment coefficient α , (see 5.5.5), an apparent flexural strength $f_{xd2,app}$ may be calculated by equating the design moment of resistance of the bed joint reinforced section to an unreinforced section of the same thickness, using expression (6.27):

$$f_{xd2,app} = \frac{6 A_s f_{yd} z}{t^2} \quad (6.27)$$

where:

- f_{yd} is the design strength of the bed joint reinforcement;
- A_s is the cross-sectional area of the bed joint reinforcement in tension, per m;
- t is the thickness of the wall;
- z is the lever arm from equation (6.23).

6.6.3 Flanged Reinforced Members

(1) In reinforced members, where the reinforcement is concentrated locally such that the member can act as a flanged member, for example with a T or L shape (see figure 6.6), the thickness of the flange, t_f , should be taken as the thickness of the masonry but in no case greater than $0,5 d$, where d is the effective depth of the member. The masonry between the concentrations of reinforcement should be checked to ensure that it is capable of spanning between the supports so provided.

$$b_{ef,l} = \text{the lesser of } \begin{cases} t_{r1} + 6t_f \\ l_{ef} / 2 \\ h/6 \\ \text{actual width of flange} \end{cases} \quad b_{ef,t} = \text{the lesser of } \begin{cases} t_{r2} + 12t_f \\ l_{ef} \\ h/3 \\ \text{actual width of flange} \end{cases}$$

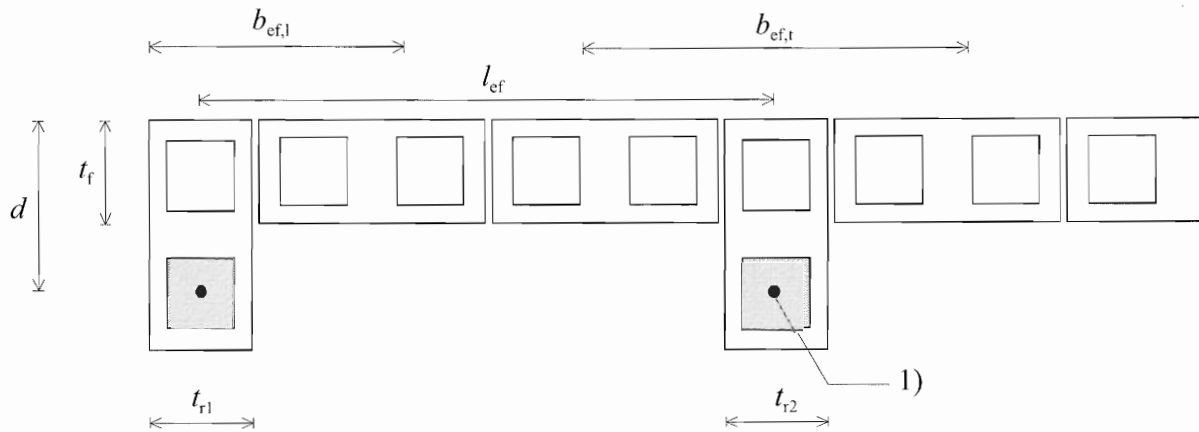
**Key**

- 1) reinforcement

Figure 6.6 — Effective width of flanges

where:

- $b_{ef,l}$ effective width of a L-shaped flanged member;
- $b_{ef,t}$ effective width of a T-shaped flanged member;
- d effective depth of the member;
- h clear height of a masonry wall;
- l_{ef} effective distance between lateral restraints;
- t_f thickness of a flange;
- t_{ri} thickness of a rib, *i*."

AC1

(2) The effective width of the flanged members, b_{ef} , should be taken as the least of:

(i) For T-members:

- the actual width of the flange;
- the width of the pocket or rib plus 12 times the thickness of the flange;
- the spacing of the pockets or ribs;

— one-third the height of the wall.

(ii) For L-members:

— the actual width of the flange;

— the width of the pocket or rib plus 6 times the thickness of the flange;

— half the spacing of the pockets or ribs;

— one-sixth the height of the wall.

(3) In the case of flanged members, the design value of the moment of resistance, M_{Rd} , can be obtained using equation (6.22) but should not be taken to be greater than:

$$M_{Rd} \leq f_d b_{cf} t_f (d - 0,5 t_f) \quad (6.28)$$

where:

f_d is the design compressive strength of the masonry, obtained from 2.4.1 and 3.6.1;

d is the effective depth of the member;

t_f is the thickness of the flange in accordance with the requirements of (1) and (2);

b_{cf} is the effective width of the flanged member, in accordance with the requirements of (1) and (2).

6.6.4 Deep beams

(1) In the case of deep beams, the design value of the moment resistance, M_{Rd} , can be obtained from equation (6.22),

where:

A_s is the area of reinforcement in the bottom of the deep beam;

f_{yd} is the design strength of the reinforcing steel; f_{yk}

z is the lever arm, which should be taken as the lesser of the following values:

$$z = 0,7 l_{ef} \quad (6.29)$$

or

$$z = 0,4 h + 0,2 l_{ef} \quad (6.30)$$

l_{ef} is the effective span of the masonry beam;

h is the clear height of the deep beam.

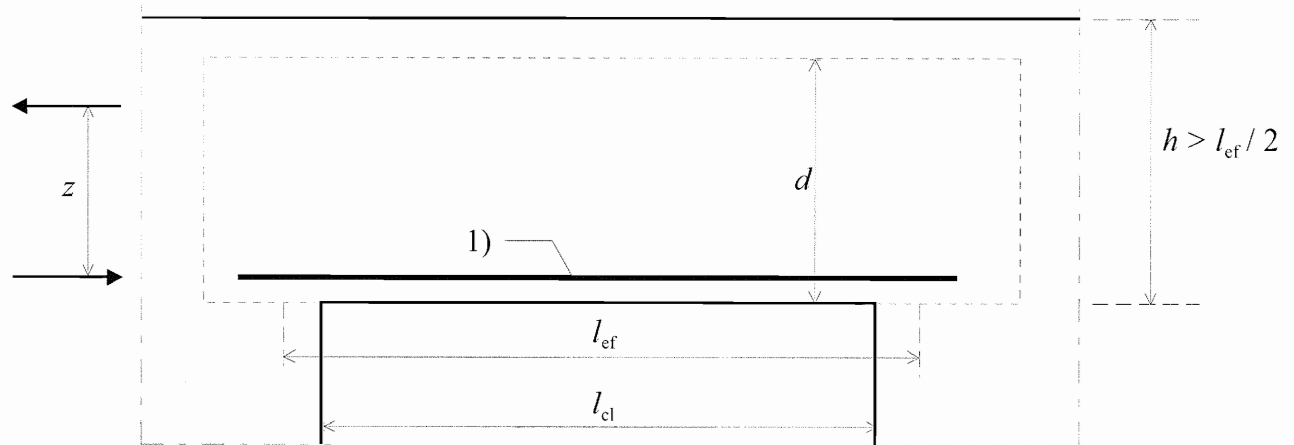
**Key**

1) reinforcement

Figure 6.7 — Reinforcement of a deep beam

(2) The design value of the moment of resistance, M_{Rd} , should not be taken to be greater than:

$$\boxed{\text{AC1}} M_{Rd} \leq 0,4 f_d b d^2 \text{ for Group 1 units other than lightweight aggregate units} \quad (6.31a) \quad \boxed{\text{AC1}}$$

and

$$\boxed{\text{AC1}} M_{Rd} \leq 0,3 f_d b d^2 \text{ for Group 2, 3 and 4 and Group 1 lightweight aggregate units;} \quad (6.31b) \quad \boxed{\text{AC1}}$$

where:

b is the width of the beam;

d is the effective depth of the beam which may be taken as $1,3 z$;

f_d is the design compressive strength of the masonry in the direction of loading, obtained from 2.4.1 and 3.6.1, or concrete infill, obtained from 2.4.1 and 3.3, whichever is the lesser.

(3) To resist cracking, reinforcement should be provided in the bed joints above the main reinforcement, to a height of $0,5 l_{ef}$ or $0,5 d$, whichever is the lesser, from the bottom face of the beam (see 8.2.3(3) and figure 6.7).

(4) The reinforcing bars should be continuous or properly lapped over the full effective span, l_{ef} , and be provided with the appropriate anchorage length in accordance with 8.2.5.

(5) The resistance of the compression zone of the deep beam should be verified against buckling, if unrestrained, using the method for vertical loading on walls contained in 6.1.2.

(6) The deep beam should be verified for vertical loadings in the vicinity of its supports.

6.6.5 Composite lintels

(1) Where reinforced or prestressed prefabricated lintels are used to act compositely with the masonry above the lintel in order to provide the tension element, and where the stiffness of the lintel is small compared with that of the wall above, the design may be based on 6.6.4, provided that the bearing length at each end of the prefabricated lintel is justified by calculation for anchorage and bearing, but is not less than 100 mm (see figure 6.8).

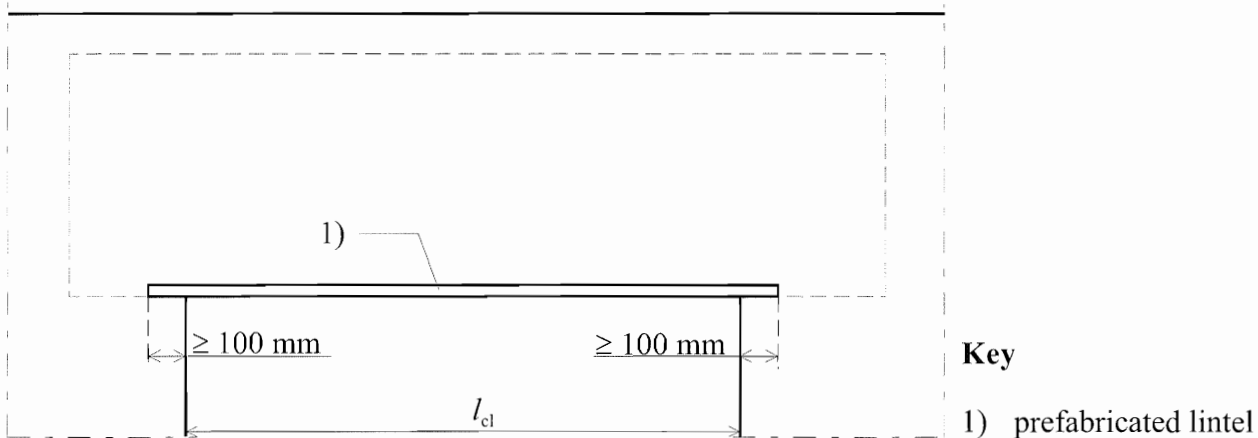

Figure 6.8 — Composite lintel forming a deep beam

6.7 Reinforced masonry members subjected to shear loading

6.7.1 General

(1)P At the ultimate limit state the design value of the shear load applied to a reinforced masonry member, V_{Ed} , shall be less than or equal to the design value of the shear resistance of the member, V_{Rd} , such that:

$$V_{Ed} \leq V_{Rd} \quad (6.32)$$

(2) The design shear resistance of reinforced masonry members, V_{Rd} , may be calculated either by:

— ignoring the contribution of any shear reinforcement incorporated into the member, where the minimum area of shear reinforcement, as required by 8.2.3(5), is not provided,

or

— taking into account the contribution of the shear reinforcement, where at least the minimum area of shear reinforcement is provided.

(3) The extent of any contribution of concrete infill to the shear resistance of the reinforced masonry member should be considered, and, where the concrete infill makes a much greater contribution to the shear resistance than the masonry, EN 1992-1-1 should be used and the strength of the masonry should be ignored.

6.7.2 Verification of reinforced masonry walls subjected to horizontal loads in the plane of the wall

(1) For reinforced masonry walls containing vertical reinforcement, when the contribution of any shear reinforcement is being ignored, it should be verified that:

$$V_{Ed} \leq V_{Rd1} \quad (6.33)$$

where:

V_{Rd1} is the design value of the shear resistance of unreinforced masonry, and is given by

$$V_{Rd1} = f_{vd} t l \quad (6.34)$$

f_{vd} is the design shear strength of masonry, obtained from 2.4.1 and 3.6.2, or concrete infill, obtained from 2.4.1 and 3.3, whichever is the lesser;

t is the thickness of the wall;

l is the length of the wall.

NOTE Where appropriate, an enhancement in the design shear strength, f_{vd} , may be taken into account in the calculation of V_{Rd1} to allow for the presence of vertical reinforcement.

(2) For reinforced masonry walls containing vertical reinforcement, when horizontal shear reinforcement is taken into account, it should be verified that:

$$V_{Ed} \leq V_{Rd1} + V_{Rd2} \quad (6.35)$$

where:

V_{Rd1} is given by equation (6.34), and

V_{Rd2} is the design value of the contribution of the reinforcement, given by:

$$V_{Rd2} = 0,9 A_{sw} f_{yd}; \quad (6.36)$$

A_{sw} is the total area of the horizontal shear reinforcement over the part of the wall being considered;

f_{yd} is the design strength of the reinforcing steel.

(3) Where shear reinforcement is taken into account, it should also be verified that:

$$\frac{V_{Rd1} + V_{Rd2}}{t l} \leq 2,0 \text{ N/mm}^2 \quad (6.37)$$

where:

t is the thickness of the wall;

l is the length or, where appropriate, the height of the wall.

6.7.3 Verification of reinforced masonry beams subjected to shear loading

(1) For reinforced masonry beams when the contribution of any shear reinforcement is being ignored, it should be verified that:

$$V_{Ed} \leq V_{Rd1} \quad (6.38)$$

where:

V_{Rd1} is given by

$$V_{Rd1} = f_{vd} b d; \quad (6.39)$$

f_{vd} is the design shear strength of masonry, obtained from 2.4.1 and 3.6.2, or concrete infill, obtained from 2.4.1 and 3.3, whichever is the lesser;

b is the minimum width of the beam over the effective depth;

d is the effective depth of the beam.

NOTE Where required, an enhancement in the design shear strength, f_{vd} , may be taken into account in the calculation of V_{Rd1} to allow for the presence of longitudinal reinforcement, see Annex J.

(2) The value of f_{vd} for use in determining V_{Rd1} , at a section α_x from the face of a support, may be increased by a factor

$$\frac{2 d}{\alpha_x} \leq 4 \quad (6.40)$$

where:

d is the effective depth of the beam;

α_x is the distance from the face of the support to the cross-section being considered;

provided that the increased value of f_{vd} is not taken to be greater than 0,3 N/mm².

NOTE See Annex J.

(3) For masonry beams when shear reinforcement is taken into account, it should be verified that:

$$V_{Ed} \leq V_{Rd1} + V_{Rd2} \quad (6.41)$$

where:

V_{Rd1} is given by equation (6.39) and

V_{Rd2} is given by:

$$\boxed{\text{AC}_1} V_{Rd2} = 0,9 d \frac{A_{sw}}{s} f_{yd} (1 + \cot \alpha) \sin \alpha \quad (6.42) \quad \boxed{\text{AC}_1}$$

d is the effective depth of the beam;

A_{sw} is the area of shear reinforcement;

s is the spacing of shear reinforcement;

α is the angle of shear reinforcement to the axis of the beam between 45° and 90° ;

f_{yd} is the design strength of the reinforcing steel.

(4) It should also be verified that:

$$V_{Rd1} + V_{Rd2} \leq 0,25 f_d b d \quad (6.43)$$

where:

f_d is the design compressive strength of the masonry in the direction of loading, obtained from 2.4.1 and 3.6.1, or the concrete infill, obtained from 2.4.1 and 3.3, whichever is the lesser;

b is the minimum width of the beam within the effective depth;

d is the effective depth of the beam.

6.7.4 Verification of deep beams subjected to shear loading

(1) The verification given in 6.7.3 should be carried out, taking V_{Ed} as the shear force at the edge of the support, and the effective depth of the beam as $d = 1,3 z$.

6.8 Prestressed masonry

6.8.1 General

(1) The design of prestressed masonry members should be based on the relevant principles given in EN 1992-1-1 with the design requirements and properties of materials as set out in sections 3, 5 and 6 of this EN 1996-1-1.

(2) The design principles are applicable to members prestressed in one direction only.

NOTE In design, the serviceability limit state should be assessed first in bending and then the bending, axial and shear strengths should be verified at the ultimate limit state.

(3)P The initial prestressing force applied shall be limited to an acceptable proportion of the characteristic ultimate load of the tendons to ensure safety against tendon failure.

NOTE The partial factor for loads should be obtained from EN 1990 for transfer of prestress and under prestressing losses.

(4) Loadbearing stresses and lateral bursting tensile forces at anchorages should be limited so as to avoid an ultimate load failure condition. Local bearing stresses may be limited by consideration of prestressing load acting in either the parallel or perpendicular direction to the bed joints. The anchorage design should consider the containment of the bursting tensile forces. The tensile stresses in the masonry should be limited to zero.

(5)P Due allowance shall be made in the design for losses in prestressing forces that can occur.

(6) Losses in prestressing forces will result from a combination of:

- relaxation of tendons;
- elastic deformation of the masonry;
- moisture movement of masonry;
- creep of masonry;
- tendon losses during anchoring;
- friction effects;
- thermal effects.

6.8.2 Verification of Members

(1)P The design of prestressed masonry members in bending shall be based upon the following assumptions:

- in the masonry, plane sections remain plane;
- the stress distribution over the compressive zone is uniform and does not exceed f_d ;
- the limiting compressive strain in the masonry is taken as -0,0035, for Group 1 units and -0,002 for Group 2, 3 and 4;
- the tensile strength of the masonry is ignored;
- bonded tendons or any other bonded reinforcement are subject to the same variations in strain as the adjacent masonry;
- stresses in bonded tendons or any other bonded reinforcement are derived from the appropriate stress-strain relationship;
- stresses in unbonded tendons in post-tensioned members are limited to an acceptable proportion of their characteristic strength;

— the effective depth to unbonded tendons is determined taking into account any freedom of the tendons to move.

(2)P The resistance of prestressed masonry members at the ultimate limit state shall be calculated using acceptable theory in which all material behaviour characteristics and second order effects are taken into account.

(3) Where prestressing forces are considered as actions, the partial factors should be obtained from EN 1992-1-1.

(4) When members subjected to vertical loading in the plane of the member are of solid rectangular cross section, the design method may be as given in 6.1.2 for unreinforced masonry. For non-solid rectangular members, geometric properties will need to be calculated. The prestressing of a member may need to be limited depending upon its effective slenderness and axial load carrying capacity.

(5)P The design shear resistance of prestressed masonry members shall be greater than the design value of the applied shear load.

6.9 Confined masonry

6.9.1 General

(1)P The design of confined masonry members shall be based on similar assumptions to those set out for unreinforced and for reinforced masonry members.

6.9.2 Verification of members

(1) In the verification of confined masonry members subjected to bending and/or axial loading, the assumptions given in this EN 1996-1-1 for reinforced masonry members should be adopted. In determining the design value of the moment of resistance of a section a rectangular stress distribution may be assumed, based on the strength of the masonry, only. Reinforcement in compression should also be ignored.

(2) In the verification of confined masonry members subjected to shear loading the shear resistance of the member should be taken as the sum of the shear resistance of the masonry and of the concrete of the confining elements. In calculating the shear resistance of the masonry the rules for unreinforced masonry walls subjected to shear loading should be used, considering for l_c the length of the masonry element. Reinforcement of confining elements should not be taken into account.

(3) In the verification of confined masonry members subjected to lateral loading, the assumptions set out for unreinforced and reinforced masonry walls should be used. The contribution of the reinforcement of the confining elements should be considered.

Section 7 Serviceability Limit State

7.1 General

(1)P A masonry structure shall be designed and constructed so as not to exceed the Serviceability Limit State.

(2) Deflections that might adversely affect partitions, finishings (including added materials) or technical equipment, or might impair water-tightness should be checked.

(3) The serviceability of masonry members should not be unacceptably impaired by the behaviour of other structural elements, such as deformations of floors or walls.

7.2 Unreinforced masonry walls

(1)P Allowance shall be made for differences in the properties of masonry materials so as to avoid overstressing or damage where they are inter-connected.

(2) In unreinforced masonry structures the serviceability limit state for cracking and deflection need not be checked separately when the Ultimate Limit States have been satisfied.

NOTE It should be borne in mind that some cracking could result when the ultimate limit state is satisfied, e. g. roofs.

(3) Damage, due to stresses arising from restraints, should be avoided by appropriate specification and detailing (see section 8).

(4)P Masonry walls subjected to lateral wind loads shall not deflect adversely under such loads, or accidental contact of persons, nor respond disproportionately to accidental impacts.

(5) A laterally loaded wall that satisfies the verification under the Ultimate Limit State may be considered to satisfy 7.1(1)P if its dimensions $\boxed{AC_1}$ are limited.

NOTE The limiting values may be obtained from Annex F. $\boxed{AC_1}$

7.3 Reinforced masonry members

(1)P Reinforced masonry members shall not crack unacceptably or deflect excessively under serviceability loading conditions.

(2) Where reinforced masonry members are sized so as to be within the limiting dimensions given in 5.5.2.5, it may be assumed that the lateral deflection of a wall and the vertical deflection of a beam will be acceptable.

(3) When the modulus of elasticity is used in calculations of deflections, the long-term modulus of elasticity, E_{longterm} should be applied as obtained from 3.7.2.

(4) Cracking of reinforced masonry members subjected to bending - e. g. reinforced masonry beams - will be limited so as to satisfy the serviceability limit state when the limiting dimensions in 5.5.2.5 and the detailing requirements in section 8 are followed.

NOTE Where cover to the tension reinforcement exceeds the minimum requirements given in 8.2.2, the possibility of surface cracking may need to be considered.

7.4 Prestressed masonry members

(1)P Prestressed masonry members shall not exhibit flexural cracking nor deflect excessively under serviceability loading conditions.

(2) Serviceability load conditions at transfer of prestress and under design loads after prestressing losses should be considered. Other design cases may exist for specific structural forms and loading conditions.

(3)P The analysis of a prestressed masonry member under the serviceability limit state shall be based on the following assumptions:

- in the masonry, plane sections remain plane;
- stress is proportional to strain;
- tensile stress in the masonry is limited so as to avoid excessive crack widths and to ensure durability of the prestressing steel;
- the prestressing force is constant after all losses have occurred.

(4) If the assumptions in (3)P, above, are followed, serviceability limit states will be satisfied, although additional deflection verification may need to be carried out.

7.5 Confined masonry members

(1)P Confined masonry members shall not exhibit flexural cracking nor deflect excessively under serviceability loading conditions.

(2)P The verification of confined masonry members at the serviceability limit states shall be based on the assumptions given for unreinforced masonry members.

7.6 Walls subjected to concentrated loads

(1) Bearings that satisfy the ultimate limit state when verified in accordance with equations (6.9), (6.10) or (6.11) may be deemed to satisfy the serviceability limit state.

Section 8 Detailing

8.1 Masonry details

8.1.1 Masonry materials

(1)P Masonry units shall be suitable for the type of masonry, its location and its durability requirements. Mortar, concrete infill and reinforcement shall be appropriate to the type of unit and the durability requirements.

AC1 (2) Masonry mortars for use in reinforced masonry, other than bed joint reinforced masonry, should not have a compressive strength, f_m , less than 4 N/mm^2 , and for use in bed joint reinforced masonry, not less than 2 N/mm^2 . AC1

8.1.2 Minimum thickness of wall

(1)P The minimum thickness of a wall shall be that required to give a robust wall.

(2) The minimum thickness, t_{\min} , of a loadbearing wall should satisfy the outcome of the calculations according to this standard.

NOTE The value of t_{\min} to be used in a Country may be found in its National Annex. The recommended value equals the outcome of the calculations.

8.1.3 Minimum area of wall

(1)P A load-bearing wall shall have a minimum net area on plan of 0,04 m², after allowing for any chases or recesses.

8.1.4 Bonding of masonry

8.1.4.1 Manufactured units

(1)P Masonry units shall be bonded together with mortar in accordance with proven practice.

(2)P Masonry units in an unreinforced masonry wall shall be overlapped on alternate courses so that the wall acts as a single structural element.

(3) In unreinforced masonry, masonry units less than or equal to a height of 250 mm should overlap by a length equal to at least 0,4 times the height of the unit or 40 mm, whichever is the greater (see figure 8.1). For units greater than 250 mm high, the overlap should be the greater of 0,2 times the height of the unit or 100 mm. At corners or junctions, the overlap of the units should not be less than the thickness of the units if this would be less than the requirements given above; cut units should be used to achieve the specified overlap in the remainder of the wall.

NOTE The length of walls and the size of openings and piers preferably should suit the dimensions of the units so as to avoid excessive cutting.

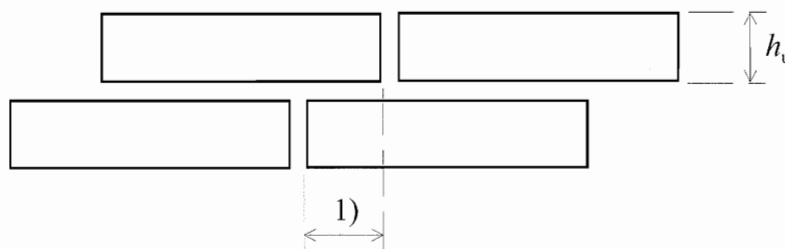

Key

1) overlap $\left\{ \begin{array}{l} \text{when } h_u \leq 250 \text{ mm : overlap } \geq 0,4 h_u \text{ or } 40 \text{ mm, whichever is the greater} \\ \text{when } h_u > 250 \text{ mm : overlap } \geq 0,2 h_u \text{ or } 100 \text{ mm, whichever is the greater} \end{array} \right.$

Figure 8.1 — Overlap of masonry units

(4) Bonding arrangements not meeting the minimum overlap requirements may be used in reinforced masonry where experience or experimental data indicate that they are satisfactory.

NOTE When a wall is reinforced, the degree of overlap can be determined as part of the design of the reinforcement.

(5) Where non-loadbearing walls abut loadbearing walls, allowance for differential deformation due to creep and shrinkage should be taken into account. When such walls are not bonded together, they should be tied together with suitable connectors allowing for differential deformations.

(6) The differential deformation behaviour of materials should be taken into account if different materials are to be rigidly connected together.

8.1.4.2 Dimensioned natural stone units

(1) Sedimentary and metamorphosed sedimentary natural stone should normally be specified to be laid with its bedding planes horizontal or near horizontal.

(2) Adjacent natural stone masonry facing units should overlap by a distance equal to at least 0,25 times the dimension of the smaller unit, with a minimum of 40 mm, unless other measures are taken to ensure adequate strength.

(3) In walls where the masonry units do not extend through the thickness of the wall, bonding units with a length equal to between 0,6 and 0,7 times the thickness of the wall, should be built at a spacing not exceeding 1 m, both vertically and horizontally. Such masonry units should have a height not less than 0,3 times their length.

8.1.5 Mortar joints

(1) Bed joints and perpend joints made with general purpose and lightweight mortars should have $\boxed{AC_1}$ an actual thickness $\langle AC_1 \rangle$ not less than 6 mm nor more than 15 mm, and bed and perpend joints made with thin layer mortars should have $\boxed{AC_1}$ an actual thickness $\langle AC_1 \rangle$ not less than 0,5 mm nor more than 3 mm

NOTE Joints of thickness between 3 mm and 6 mm may be constructed if the mortars have been specially developed for the particular use, when the design may be based on the use of general purpose mortar.

(2) Bed joints should be horizontal unless the designer specifies otherwise.

(3) When units that rely on mortar pockets are used, perpend joints can be considered to be filled if mortar is provided to the full height of the joint over a minimum of 40 % of the width of the unit. Perpend joints in reinforced masonry subject to bending and shear across the joints should be fully filled with mortar.

8.1.6 Bearings under concentrated loads

(1) Concentrated loads should bear on a wall a minimum length of 90 mm or such distance as is required from calculations according to 6.1.3, whichever is the greater.

8.2 Reinforcement details

8.2.1 General

(1)P Reinforcing steel shall be located such that it acts compositely with the masonry.

(2)P Where simple supports are assumed in the design, consideration shall be given to the effects of any fixity that might be provided by the masonry.

(3) Reinforcing steel in masonry designed as a bending member should be provided over a support where the masonry is continuous, whether the beam has been designed as continuous or not. Where this occurs, an area of steel not less than 50 % of the area of the tension reinforcement required at midspan should be provided in the top of the masonry over the support and anchored in accordance with 8.2.5.1. In all cases at least 25 % of the reinforcing steel required at midspan should be carried through to the support and similarly anchored.

8.2.2 Cover to reinforcing steel

(1) To allow bond strength to develop where reinforcing steel, selected $\overline{AC_1}$ according to 4.3.3.(3), $\overline{AC_1}$ is located in mortar in bed joints:

- the minimum depth of mortar cover from the reinforcing steel to the face of the masonry should be 15 mm (see figure 8.2);
- mortar cover above and below reinforcing steel placed in bed joints should be provided, so that the thickness of the joint is at least 5 mm greater than the diameter of the reinforcing steel, for general purpose and lightweight mortars.

NOTE By using grooves in one or both bed faces of the unit, the minimum thickness of mortar around reinforcement can be accommodated in a thinner joint.

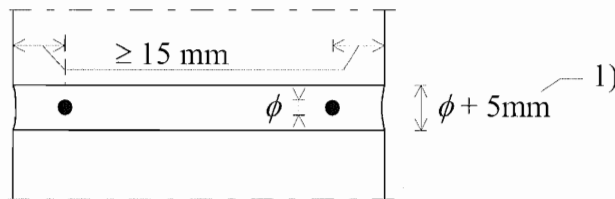

Key

- 1) for general purpose and lightweight mortars

Figure 8.2 — Cover to reinforcing steel in bed joints

(2) For filled cavity or special bond construction, the minimum cover for reinforcing steel selected according 4.3.3 (3) should be 20 mm for mortar or the concrete cover, as appropriate, or the diameter of the bar, whichever is the greater.

(3) The cut ends of all reinforcing steel, except stainless steel, should have the same minimum cover as that appropriate to unprotected carbon steel in the exposure situation being considered, unless alternative means of protection are used.

8.2.3 Minimum area of reinforcement

(1) In reinforced masonry members where reinforcing steel is provided to enhance the strength in the plane of the member, the area of main steel should not be less than 0,05 % of the effective cross-sectional area of the member, taken as the product of its effective width and its effective depth.

(2) In walls where reinforcing steel is provided in the bed joints to enhance resistance to lateral **AC1** (out-of-plane) **AC1** loads, the total area of such reinforcement should not be less than 0,03 % of the gross cross-sectional area of the wall (i. e. 0,015 % in each face).

(3) Where reinforcement is provided in bed joints to help control cracking or to provide ductility, the total area of the steel should not be less than 0,03 % of the gross cross-sectional area of the wall.

(4) In reinforced grouted cavity masonry members designed to span in one direction only, secondary reinforcing steel should be provided in the direction perpendicular to the main steel principally to distribute stresses. The area of this secondary reinforcing steel should not be less than 0,05 % of the cross-sectional area of the member, taken as the product of its effective width and its effective depth.

(5) Where shear reinforcing steel is required in the member (see 6.7.3), the area of shear reinforcement should not be less than 0,05 % of the cross-sectional area of the member, taken as the product of its effective width and its effective depth.

8.2.4 Size of reinforcing steel

(1)P The maximum size of reinforcing steel used shall be such as to enable proper embedment in the mortar or concrete infill.

(2) Reinforcing steel in bar form should have a minimum diameter of 5 mm.

(3)P The maximum size of reinforcing steel used shall be such that the anchorage stresses, as given in 8.2.5, are not exceeded and the cover to the reinforcement, as given in 8.2.2, is maintained.

8.2.5 Anchorage and laps

8.2.5.1 Anchorage of tension and compression reinforcing steel

(1)P Reinforcing steel shall be provided with sufficient anchorage length so that the internal forces to which it is subjected are transmitted to the mortar or concrete infill and that longitudinal cracking or spalling of the masonry does not occur.

(2) Anchorage should be achieved by straight anchorage, hooks, bends or loops as shown in figure 8.3. Alternatively stress transfer may be by means of an appropriate mechanical device proven by tests.

(3) Straight anchorage or bends (see figure 8.3 (a) and (b)) should not be used to anchor plain reinforcing steel of more than 8 mm diameter. Hooks, bends or loops should not be used to anchor reinforcing steel in compression.

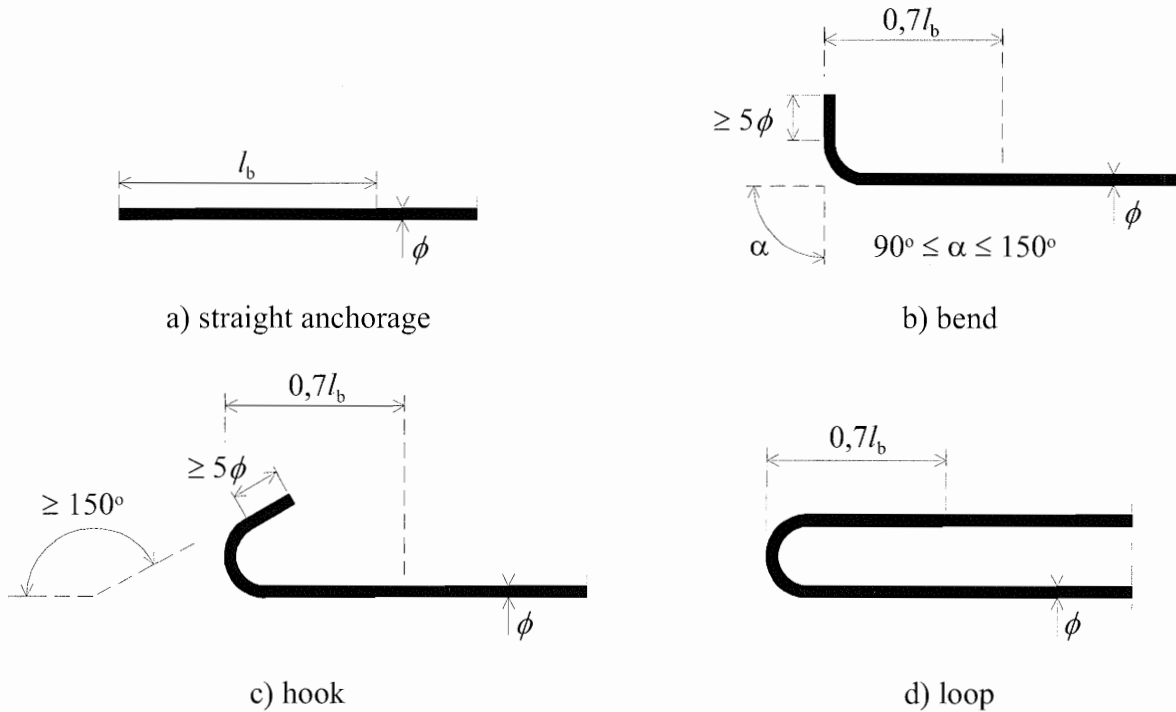

Figure 8.3 — Anchorage details

(4) The straight anchorage length l_b required for a bar, assuming constant bond stress, should be obtained from:

$$\boxed{\text{AC1}} l_b = \frac{\phi}{4} \frac{f_{yd}}{f_{bod}} \quad (8.1) \quad \boxed{\text{AC1}}$$

where:

ϕ is the effective diameter of the reinforcing steel;

f_{yd} is the design strength of reinforcing steel, obtained from 2.4.1 and 3.4.2;

f_{bod} is the design anchorage strength of reinforcing steel, obtained from table 3.5 or 3.6 and 3.6.4, as appropriate, and 2.4.1.

(5) For bars ended by hooks, bends and loops (see Figure 8.3 (b), (c) and (d)), the anchorage length in tension may be reduced to $0,7 l_b$.

(6) Where a greater area of reinforcing steel is provided than is required by design, the anchorage length may be reduced proportionally provided that:

(i) For reinforcing steel in tension the anchorage length is not less than the greater of:

— $0,3 l_b$, or

— 10 bar diameters, or

— 100 mm.

(ii) For reinforcing steel in compression the anchorage length is not less than the greater of:

— $0,6 l_b$, or

— 10 bar diameters, or

— 100 mm.

(7) When anchoring reinforcing bars, transverse reinforcing steel should be provided evenly distributed along the anchorage length, with at least one reinforcing steel bar placed in the region of a curved anchorage (see figure 8.3 (b), (c) and (d)). The total area of transverse reinforcing steel should be not less than 25 % of the area of one anchored reinforcing steel bar.

(8) Where prefabricated bed joint reinforcement is used, the anchorage length should be based on the characteristic anchorage bond strength determined by tests in accordance with EN 846-2.

8.2.5.2 Lapping of tension and compression reinforcing steel

(1)P The length of laps shall be sufficient to transmit the design forces.

(2) The lap length of two reinforcing steel bars should be calculated in accordance with 8.2.5.1, based on the smaller of the two bars lapped.

(3) The lap length between two reinforcing steel bars should be:

— l_b for bars in compression and for bars in tension where less than 30 % of the bars in the section are lapped and where the clear distance between the lapped bars in a transverse direction is not less than 10 bar diameters and the concrete or mortar cover is not less than 5 bar diameters.

— $1,4 l_b$ for bars in tension where either 30 % or more of the bars at the section are lapped or if the clear distance between the lapped bars in a transverse direction is less than 10 bar diameters or the concrete or mortar cover is less than 5 bar diameters.

— $2 l_b$ for bars in tension where both 30 % or more of the bars at the section are lapped and the clear distance between the lapped bars is less than 10 bar diameter or the concrete or mortar cover is less than 5 bar diameters.

(4) Laps between reinforcing steel bars should not be located at areas of high stress or where the dimensions of a section change, for example, a step in a wall thickness. The clear distance between two lapped bars should not be less than two bar diameters or 20 mm whichever is the greater.

(5) Where prefabricated bed joint reinforcement is used the lap length should be based on the characteristic anchorage bond strength determined by tests in accordance with EN 846-2.

8.2.5.3 Anchorage of shear reinforcing steel

(1) The anchorage of shear reinforcing steel, including stirrups, should be effected by means of hooks or bends (see figure 8.3 (b) and (c)), where appropriate, with a longitudinal reinforcing bar provided inside the hook or bend.

(2) The anchorage is considered to be effective where the curve of the hook is extended by a straight length of 5 bar diameters or 50 mm, whichever is the greater, and the curve of the bend is extended by a straight length of 10 bar diameters or 70 mm, whichever is the greater (see figure 8.4).

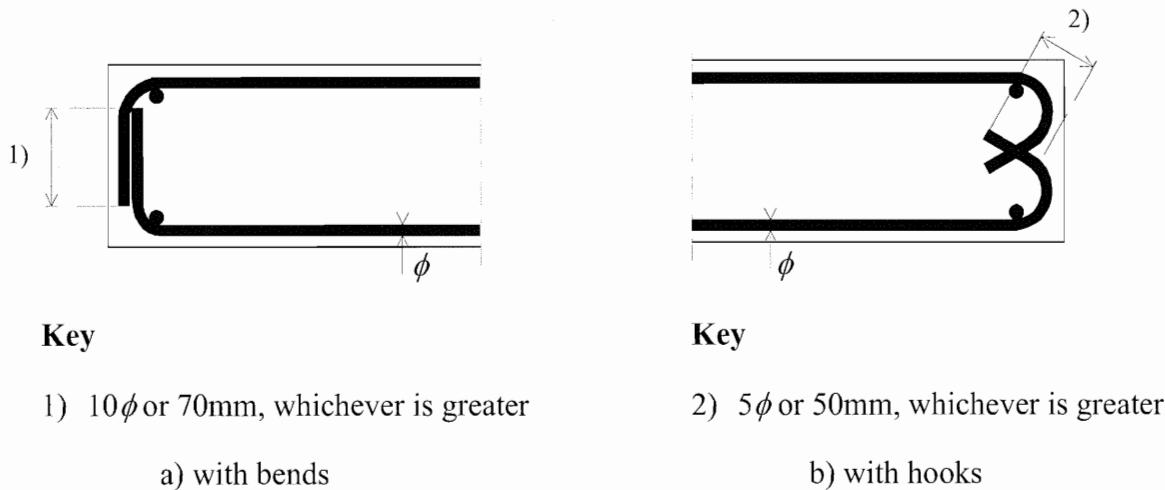

Figure 8.4 — Anchorage of shear reinforcement

8.2.5.4 Curtailment of tension reinforcing steel

(1) In any member subjected to bending, every reinforcing steel bar should extend, except at end supports, beyond the point at which it is no longer needed, for a distance equal to the effective depth of the member or 12 times the diameter of the bar, whichever is the greater. The point at which reinforcing steel is theoretically no longer needed is where the design resistance moment of the section, considering only the continuing bars, is equal to the applied design moment. However, reinforcing steel should not be curtailed in a tension zone unless at least one of the following conditions is satisfied for all arrangements of design load considered:

- the reinforcing steel bars extend at least the anchorage length appropriate to their design strength from the point at which they are no longer required to resist bending;
- the design shear capacity at the section where the reinforcing steel stops is greater than twice the shear force due to design loads, at that section;
- the continuing reinforcing steel bars at the section where the reinforcing steel stops provide double the area required to resist the bending moment at that section.

(2) Where there is little or no end fixation for a member in bending, at least 25 % of the area of the tension reinforcing steel required at mid-span should be carried through to the support. This reinforcement may be anchored in accordance with 8.2.5.1, or by providing:

— an effective anchorage length equivalent to 12 times the bar diameter beyond the centre line of the support, where no bend or hook begins before the centre of the support,

or

— an effective anchorage equivalent to 12 times the bar diameter plus $d/2$ from the face of the support, where d is the effective depth of the member, and no bend begins before $d/2$ inside the face of the support.

(3) Where the distance from the face of a support to the nearer edges of a principal load is less than twice the effective depth, all the main reinforcing steel in a member subjected to bending should continue to the support and be provided with an anchorage equivalent to 20 times the bar diameter.

8.2.6 Restraint of compression reinforcing steel

(1)P Reinforcing steel bars in compression shall be restrained to prevent local buckling.

(2) In members where the area of longitudinal reinforcing steel is greater than 0,25 % of the area of the masonry and any concrete infill, and more than 25 % of the design axial load resistance is to be used, links surrounding the longitudinal bars should be provided.

(3) Where links are required, they should be not less than 4 mm in diameter or $1/4$ of the maximum diameter of the longitudinal bars, whichever is the greater, and the spacing should not exceed the least of:

— the least lateral dimension of the wall;

— 300 mm;

— 12 times the main bar diameter.

(4) Vertical reinforcing steel corner bars should be supported by an internal angle at every link spacing and this angle should not exceed 135° . Internal vertical reinforcing bars need only be restrained by internal angles at alternate link spacings.

8.2.7 Spacing of reinforcing steel

(1)P The spacing of reinforcing steel shall be sufficiently large so as to allow the concrete infill or mortar to be placed and compacted.

(2) The clear distance between adjacent parallel reinforcing steel should not be less than the maximum size of the aggregate plus 5 mm, or the bar diameter, or 10 mm whichever is the greater.

(3) The spacing of tension reinforcement should not exceed 600 mm.

(4) When the main reinforcing steel is concentrated in cores or pockets of hollow units or small pockets formed by the arrangement of units, the total area of main reinforcing steel should not exceed 4 % of the gross cross-sectional area of the infill in the core or pocket, except at laps where it should not exceed 8 %.

(5) When a wider spacing than is allowed by (3) is required for the main reinforcing steel to be concentrated in purpose arranged pockets, the flanges of the reinforced section should be limited as in accordance with $\boxed{AC1}$ 6.6.3 $\boxed{AC1}$ and the spacing may be up to 1,5 m.

(6) Where shear reinforcing steel is required, the spacing of stirrups should not be greater than $0,75 \times$ effective depth of the member or 300 mm, whichever is lesser.

(7) Prefabricated bed joint reinforcement placed in bed joints should be spaced at 600 mm, or less, centres.

8.3 Prestressing details

(1) Detailing of prestressing devices should be in accordance with EN 1992-1-1.

8.4 Confined masonry details

(1)P Confined masonry walls shall be provided with vertical and horizontal reinforced concrete or reinforced masonry confining elements so that they act together as a single structural member when subjected to actions.

(2)P Top and sides confining elements shall be cast after the masonry has been built so that they will be duly anchored together.

(3) Confining elements should be provided at every floor level, at every interception between walls and at both sides of every opening having an area of more than 1,5 m². Additional confining elements may be required in the walls so that the maximum spacing, both horizontal and vertical is 4 m.

(4) Confining elements should have a cross-sectional area not less than 0,02 m², with a minimum dimension of 150 mm in the plan of the wall, and be provided with longitudinal reinforcements with a minimum area equivalent to 0,8 % of the cross-sectional area of the confining element, but not less than 200 mm². Stirrups not less than 6 mm diameter, spaced not more than 300 mm should also be provided. The detailing of the reinforcements should be in accordance with 8.2.

(5) In confined masonry walls where Group 1 and Group 2 Units are used, the units adjacent to the confining elements should be overlapped according to the rules prescribed in the clause 8.1.4 for bonding of masonry. Alternatively, reinforcement not less than 6 mm diameter bars or equivalent and spaced not more than 300 mm, duly anchored in the concrete infill and in the mortar joints, should be adopted.

8.5 Connection of walls

8.5.1 Connection of walls to floors and roofs

8.5.1.1 General

(1)P Where walls are assumed to be restrained by floors or roofs, the walls shall be connected to the floors or roofs so as to provide for the transfer of the design lateral loads to the bracing elements.

(2) Transfer of lateral loads to the bracing elements should be made by the floor or roof structure, for example, reinforced or precast concrete or timber joists incorporating boarding, provided the floor or roof structure is capable of developing diaphragm action, or by a ring beam capable of transferring

the resulting shear and bending action effects. Either the frictional resistance of the bearing of structural members on masonry walls, or metal straps of suitable end fixing, should be capable of resisting the transfer loads.

(3)P Where a floor or roof bears on a wall, the bearing length shall be sufficient to provide the required bearing capacity and shear resistance, allowing for manufacturing and erection tolerances.

(4) The minimum bearing length of floors or roofs on walls should be as required by calculation.

8.5.1.2 Connection by straps

(1)P Where straps are used they shall be capable of transferring the lateral loads between the wall and the restraining structural element.

(2) When the surcharge on the wall is negligible, for example, at a gable wall/roof junction, special consideration is necessary to ensure that the connection between the straps and the wall will be effective.

(3) The spacing of straps between walls and floors or roofs should be not greater than 2 m for buildings up to 4 storeys high, and 1,25 m for higher buildings.

8.5.1.3 Connection by frictional resistance

(1)P Where concrete floors, roofs or ring beams bear directly on a wall, the frictional resistance shall be capable of transferring the lateral loads.

8.5.1.4 Ring ties and ring beams

(1) When the transfer of lateral loads to the bracing elements is to be achieved by the use of ring beams, or ring ties, they should be placed in every floor level or directly below. The ring ties may consist of reinforced concrete, reinforced masonry, steel or wood and should be able to support a design tensile force of 45 kN.

(2) When the ring ties are not continuous, additional measures should be undertaken to ensure continuity.

(3) Ring ties made of reinforced concrete should contain at least two reinforcing steel bars of at least 150 mm². The laps should be designed in accordance with EN 1992-1-1 and staggered, if possible. Parallel continuous reinforcement may be considered with their full cross section provided that they are situated in floors or window lintels at a distance of not more than 0,5 m from the middle of the wall and floor, respectively.

(4) If floors without diaphragm action are used, or sliding layers are put under the floor bearings, the horizontal stiffening of the walls should be ensured by ring beams or statically equivalent measures.

8.5.2 Connection between walls

8.5.2.1 Intersections

(1)P Intersecting loadbearing walls shall be joined together so that the required vertical and lateral loads can be transferred between them.

(2) The joint at the intersection of walls should be made either by:

— masonry bond (see 8.1.4),

or

— connectors or reinforcement extending into each wall.

(3) Intersecting loadbearing walls should be erected simultaneously.

8.5.2.2 Cavity and veneer walls

(1)P The two leaves of a cavity wall shall be effectively tied together.

(2) Wall ties connecting together the two leaves of a cavity wall or between a veneer wall and its backing wall should be not less than the number calculated according to 6.5, where relevant, nor less than n_{\min} per m^2 .

NOTE 1 The requirements for the use of wall ties are given in EN 1996-2.

NOTE 2 When connecting elements, for example, prefabricated bed joint reinforcement, are used to connect two leaves of a wall together, each tying element should be treated as a wall tie.

NOTE 3 Values of n_{\min} for cavity and veneer walls, for use in a country may be found in its National Annex; the recommended value for both is 2.

8.5.2.3 Double-leaf walls

(1)P The two leaves of a double-leaf wall shall be effectively tied together.

(2) Wall ties connecting the two leaves of a double-leaf wall, calculated according to $\boxed{\text{AC}_1}$ 6.5(4) $\boxed{\text{AC}_1}$, should have a sufficient cross-sectional area with not less than j connectors per square metre of the double-leaf wall, and be evenly distributed.

NOTE 1 Some forms of prefabricated bed joint reinforcement can also function as ties between the two leaves of a double-leaf wall (see EN 845-3).

NOTE 2 The value of j for use in a country may be found in its National Annex; the recommended value is 2.

8.6 Chases and recesses on walls

8.6.1 General

(1)P Chases and recesses shall not impair the stability of the wall.

(2) Chases and recesses should not pass through lintels or other structural items built into a wall nor should they be allowed in reinforced masonry members unless specifically allowed for by the designer.

(3) In cavity walls, the provision of chases and recesses should be considered separately for each leaf.

8.6.2 Vertical chases and recesses

(1) The reduction in vertical load, shear and flexural resistance resulting from vertical chases and recesses may be neglected if such vertical chases and recesses are not deeper than $\sqrt{AC_1} t_{ch,v} \sqrt{AC_1}$; the depth of the recess or chase should include the depth of any hole reached when forming the recess or chase. If this limit is exceeded, the vertical load, shear and flexural resistance should be checked by calculation with the masonry section reduced by the chases or recesses.

Note The value of $\sqrt{AC_1} t_{ch,v} \sqrt{AC_1}$ for use in a Country may be found in its National Annex. The values given in the Table below are recommended.

Sizes of vertical chases and recesses in masonry, allowed without calculation

Thickness of wall mm	Chases and recesses formed after construction of masonry		Chases and recesses formed during construction of masonry	
	max depth mm	max width mm	minimum wall thickness remaining mm	max width mm
85 - 115	30	100	70	300
116 – 175	30	125	90	300
176 – 225	30	150	140	300
226 – 300	30	175	175	300
> 300	30	200	215	300

NOTE 1 The maximum depth of the recess or chase should include the depth of any hole reached when forming the recess or chase.

NOTE 2 Vertical chases which do not extend more than one third of the storey height above floor level may have a depth up to 80 mm and a width up to 120 mm, if the thickness of the wall is 225 mm or more.

NOTE 3 The horizontal distance between adjacent chases or between a chase and a recess or an opening should not be less than 225 mm.

NOTE 4 The horizontal distance between any two adjacent recesses, whether they occur on the same side or on opposite sides of the wall, or between a recess and an opening, should not be less than twice the width of the wider of the two recesses.

NOTE 5 The cumulative width of vertical chases and recesses should not exceed 0,13 times the length of the wall.

8.6.3 Horizontal and inclined chases

(1) Any horizontal and inclined chases should be positioned within one eighth of the clear height of the wall, above or below a floor. The total depth, including the depth of any hole reached when forming the chase, should be less than $\sqrt{AC_1} t_{ch,h} \sqrt{AC_1}$ providing that the eccentricity in the region of the chase is less than $t/3$. If this limit is exceeded, the vertical load, shear and flexural resistance should be checked by calculation taking the reduced cross section into account.

Note The value of $\sqrt{AC_1} t_{ch,h} \sqrt{AC_1}$ for use in a Country may be found in its National Annex. The values given in the Table below are recommended.

Sizes of horizontal and inclined chases in masonry, allowed without calculation

Thickness of wall mm	Maximum depth mm	
	Unlimited length	Length \leq 1 250 mm
85 - 115	0	0
116 - 175	0	15
176 - 225	10	20
226 - 300	15	25
over 300	20	30

NOTE 1 The maximum depth of the chase should include the depth of any hole reached when forming the chase.

NOTE 2 The horizontal distance between the end of a chase and an opening should not be less than 500 mm.

NOTE 3 The horizontal distance between adjacent chases of limited length, whether they occur on the same side or on opposite sides of the wall, should be not less than twice the length of the longest chase.

NOTE 4 In walls of thickness greater than 175 mm, the permitted depth of the chase may be increased by 10 mm if the chase is machine cut accurately to the required depth. If machine cuts are used, chases up to 10 mm deep may be cut in both sides of walls of thickness not less than 225 mm.

NOTE 5 The width of chase should not exceed half the residual thickness of the wall.

8.7 Damp proof courses

(1)P Damp proof courses shall be capable of transferring the horizontal and vertical design loads without suffering or causing damage; they shall have sufficient surface frictional resistance to prevent unintended movement of the masonry resting on them.

8.8 Thermal and long term movement

(1)P Allowance shall be made for the effects of movements such that the performance of the masonry is not affected adversely.

NOTE Information on the allowance for movement in masonry will be found in EN 1996-2.

Section 9 Execution

9.1 General

(1)P All work shall be constructed in accordance with the specified details within permissible deviations.

(2)P All work shall be executed by appropriately skilled and experienced personnel.

(3) If the requirements of EN 1996-2 are followed, it can be assumed that (1)P and (2)P are satisfied.

9.2 Design of structural members

(1) The overall stability of the structure or of individual walls during construction should be considered; if special precautions are needed for the site work, they should be specified.

9.3 Loading of masonry

(1)P Masonry shall not be subjected to load until it has achieved adequate strength to resist the load without damage.

(2) Backfilling against retaining walls should not be carried out until the wall is capable of resisting loads from the filling operation, taking account of any compacting forces or vibrations.

(3) Attention should be paid to walls which are temporarily unrestrained during construction, but which may be subjected to wind loads or construction loads, and temporary shoring should be provided, if necessary, to maintain stability.

Annex A
(informative)

Consideration of partial factors relating to Execution

(1) When a country links a class, or classes, of γ_M from 2.4.3 to execution control, the following should be considered in differentiating the class, or classes, of γ_M :

- the availability of appropriately qualified and experienced personnel, employed by the contractor, for supervision of the work;
- the availability of appropriately qualified and experienced personnel, independent of the contractor's staff, for the inspection of the work;

NOTE In the case of Design-and-Build contracts, the Designer may be considered as a person independent of the construction organisation for the purposes of inspection of the work, provided that the Designer is an appropriately qualified person who reports to senior management independently of the site construction team.

- assessment of the site properties of the mortar and concrete infill;
- the way in which mortars are mixed and the constituents are batched, for example, either by weight or in appropriate measuring boxes.

Annex B (informative)

Method for calculating the eccentricity of a stability core

(1) When the vertical stiffening elements do not satisfy 5.4(2), the total eccentricity of a stability core due to sway, e_t , should be calculated, in any relevant direction, from:

$$e_t = \xi \cdot \left(\frac{M_d}{N_{Ed}} + e_c \right) \quad (\text{B.1})$$

where:

M_d is the design bending moment at the bottom of the core, calculated using the linear theory of elasticity

N_{Ed} is the design vertical load at the bottom of the core, calculated using the linear theory of elasticity

e_c is an additional eccentricity

ξ is a magnification factor for the rotational stiffness of the restraint of the structural element being considered

(2) The additional eccentricity e_c and the magnification factor ξ may be calculated from equations (B.2) and (B.3) (see figure B.1):

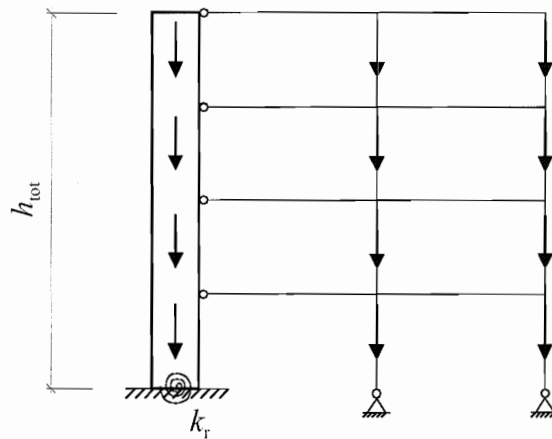

Figure B.1 — Representation of a stability core

$$\xi = \frac{k_r}{k_r - 0,5 N_d \cdot h_{tot} \cdot \frac{Q_d}{N_d}} \quad (\text{B.2})$$

$$e_c = \frac{Q_d}{N_d} \cdot 4,5 d_c \cdot \left(\frac{h_{tot}}{100 d_c} \right)^2 \quad (B.3)$$

where:

k_r is the rotational stiffness of the restraint in Nmm/rad;

NOTE The restraint can be from the foundation - see EN 1997 - or from another part of the structure, e. g. a basement.

h_{tot} is the total height of the wall or core from the foundation, in mm;

d_c is the largest dimension of the cross section of the core in the bending direction, in mm;

N_d is the design value of the vertical load at the bottom of the core, in N;

Q_d is the design value of the total vertical load, of the part of the building that is stabilized by the core being considered.

Annex C (informative)

A simplified method for calculating the out-of-plane eccentricity of loading on walls

(1) In calculating the eccentricity of loading on walls, the joint between the wall and the floor may be simplified by using uncracked cross sections and assuming elastic behaviour of the materials; a frame analysis or a single joint analysis may be used.

(2) Joint analysis may be simplified as shown in figure C.1; for less than four members, those not existing should be ignored. The ends of the members remote from the junction should be taken as fixed unless they are known to take no moment at all, when they may be taken to be hinged. The end moment at node 1, M_1 , may be calculated from equation (C.1) and the end moment at node 2, M_2 , similarly but using $\overline{\text{AC1}}E_2I_2/h_2$ instead of E_1I_1/h_1 $\overline{\text{AC1}}$ in the numerator.

$$\overline{\text{AC1}}M_1 = \frac{\frac{n_1 E_1 I_1}{h_1}}{\frac{n_1 E_1 I_1}{h_1} + \frac{n_2 E_2 I_2}{h_2} + \frac{n_3 E_3 I_3}{l_3} + \frac{n_4 E_4 I_4}{l_4}} \left[\frac{w_3 l_3^2}{4(n_3 - 1)} - \frac{w_4 l_4^2}{4(n_4 - 1)} \right] \quad (\text{C.1}) \overline{\text{AC1}}$$

where:

n_i is the stiffness factor of members is taken as 4 for members fixed at both ends and otherwise 3;

E_i is the modulus of elasticity of member i , where $i = 1, 2, 3$ or 4 ;

$\overline{\text{AC1}}$ NOTE It will normally be sufficient to take the values of E as $1\,000 f_k$ for all masonry members.

I_i is the second moment of area of member i , where $i = 1, 2, 3$ or 4 (in the case of a cavity wall in which only one leaf is loadbearing, I_i should be taken as that of the loadbearing leaf only); $\overline{\text{AC1}}$

h_1 is the clear height of member 1;

h_2 is the clear height of member 2;

l_3 is the clear span of member 3;

l_4 is the clear span of member 4;

w_3 is the design uniformly distributed load on member 3, using the partial factors from EN 1990, unfavourable effect;

w_4 is the design uniformly distributed load on member 4, using the partial factors from EN 1990, unfavourable effect.

NOTE The simplified frame model used in figure C1 is not considered to be appropriate where timber floor joists are used. For such cases refer to (5) below.

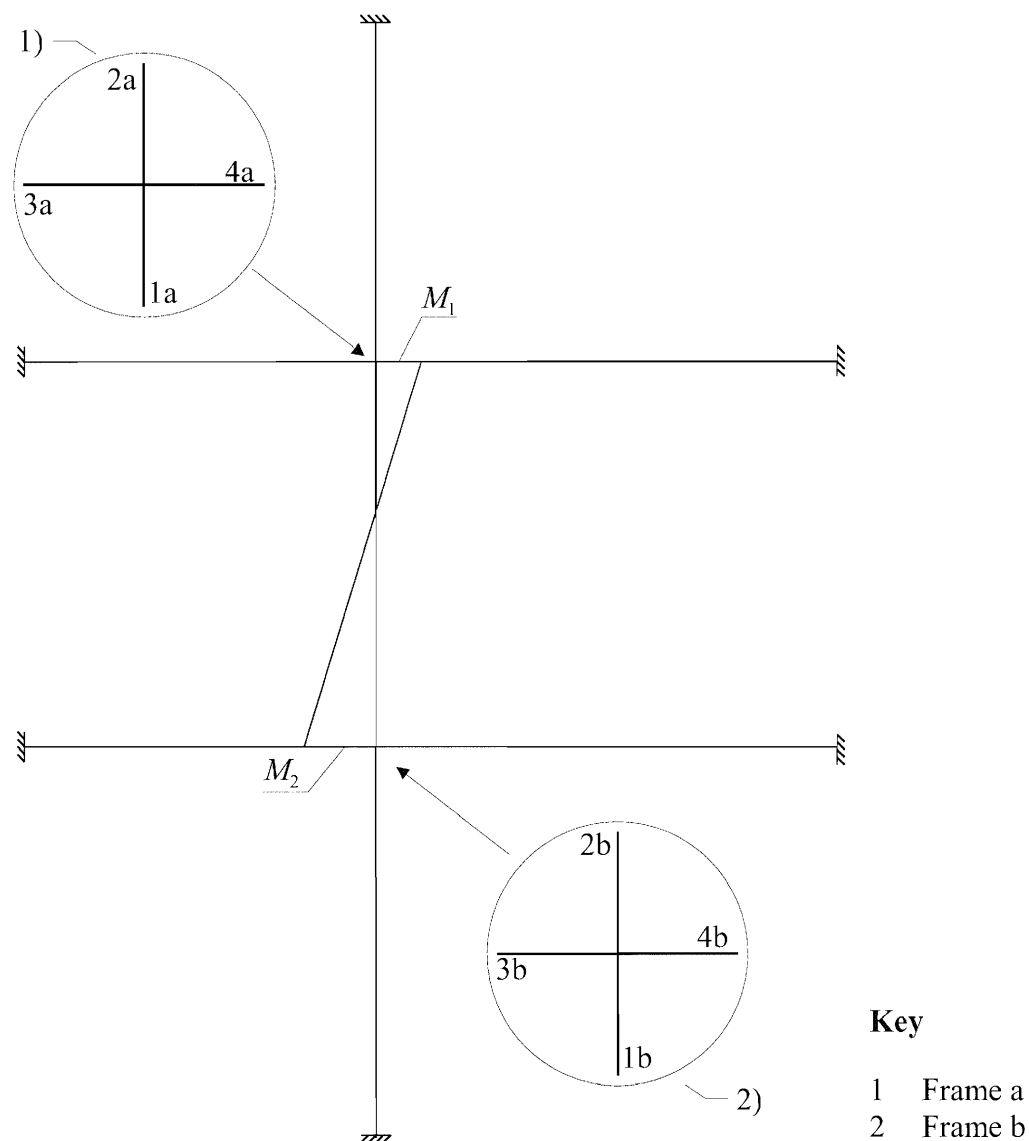

NOTE Moment M_1 is found from frame a and moment M_2 from frame b

Figure C.1 — Simplified frame diagram

(3) The results of such calculations will usually be conservative because the true fixity, i. e. the ratio of the actual moment transmitted by a joint to that which would exist if the joint was fully rigid, of the floor/wall junction cannot be achieved. It will be permissible for use in design to reduce the eccentricity, obtained from the calculations in accordance with (1) above, by multiplying it by a factor, η .

η may be obtained experimentally, or it may be taken as $\boxed{AC1}(1 - k_m / 4)$, $\boxed{AC1}$

where:

$$\boxed{\text{AC}_1} k_m = \frac{n_3 \frac{E_3 I_3}{l_3} + n_4 \frac{E_4 I_4}{l_4}}{n_1 \frac{E_1 I_1}{h_1} + n_2 \frac{E_2 I_2}{h_2}} \leq 2 \quad (\text{C.2}) \quad \boxed{\text{AC}_1}$$

where the symbols have the meaning attributed to them in (2), above.

(4) If the eccentricity calculated in accordance with (2) above is greater than 0,45 times the thickness of the wall, the design may be based on (5) below.

(5) The eccentricity of loading to be used in design may be based on the load being resisted by the minimum required bearing depth, not taken to be more than 0,1 times the wall thickness, at the face of the wall, stressed to the appropriate design strength of the material (see figure C.2).

NOTE It should be borne in mind that basing the eccentricity on this Annex may lead to sufficient rotation of the floor or beam to cause a crack on the opposite side of the wall to that of the load application.

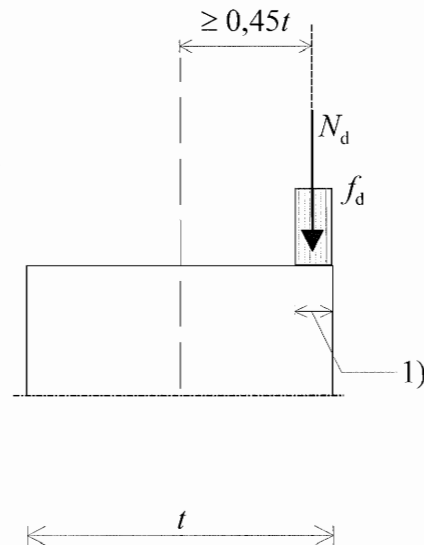

Key

1) bearing depth $\leq 0,1 t$

Figure C.2 — Eccentricity obtained from design load resisted by stress block

(6) When a floor is supported over part of the thickness of a wall, see figure C.3, the moment above the floor, M_{Edu} , and the moment below the floor, M_{Edf} , may be obtained from expressions C.3 and C.4 below, provided that the values are less than are obtained from (1), (2) and (3) above:

$$M_{\text{Edu}} = N_{\text{Edu}} \frac{(t - 3a)}{4} \quad (\text{C.3})$$

$$M_{\text{Edf}} = N_{\text{Edf}} \frac{a}{2} + N_{\text{Edu}} \frac{(t + a)}{4} \quad (\text{C.4})$$

where:

N_{Edu} is the design load in the upper wall;

N_{Edf} is the design load applied by the floor;

a is the distance from the face of the wall to the edge of the floor.

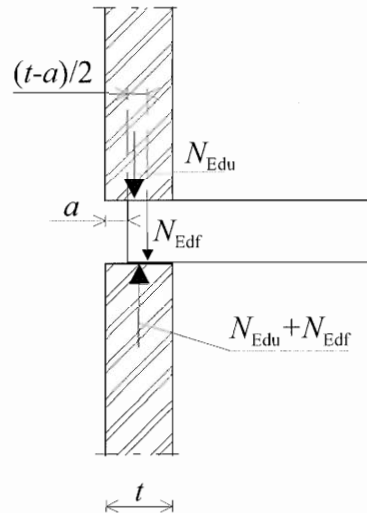

Figure C.3 — Diagram showing the forces when a floor is supported over a part of the thickness of a wall

Annex D
(informative)

Determination of ρ_3 and ρ_4

(1) This annex gives two graphs, D.1 and D.2, one for determining ρ_3 and the other for determining ρ_4 .

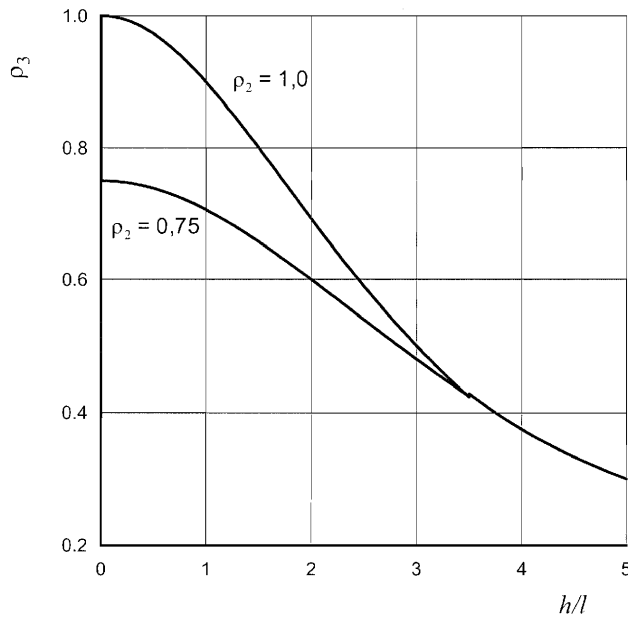

Figure D.1 — Graph showing values of ρ_3 using equations 5.6 and 5.7

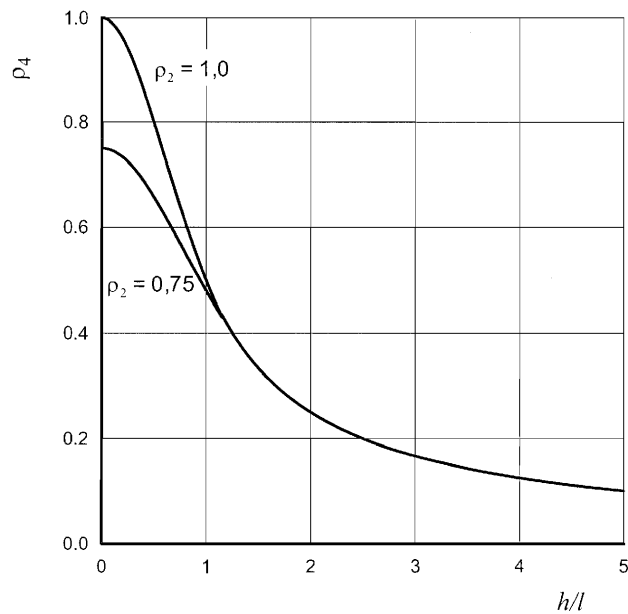
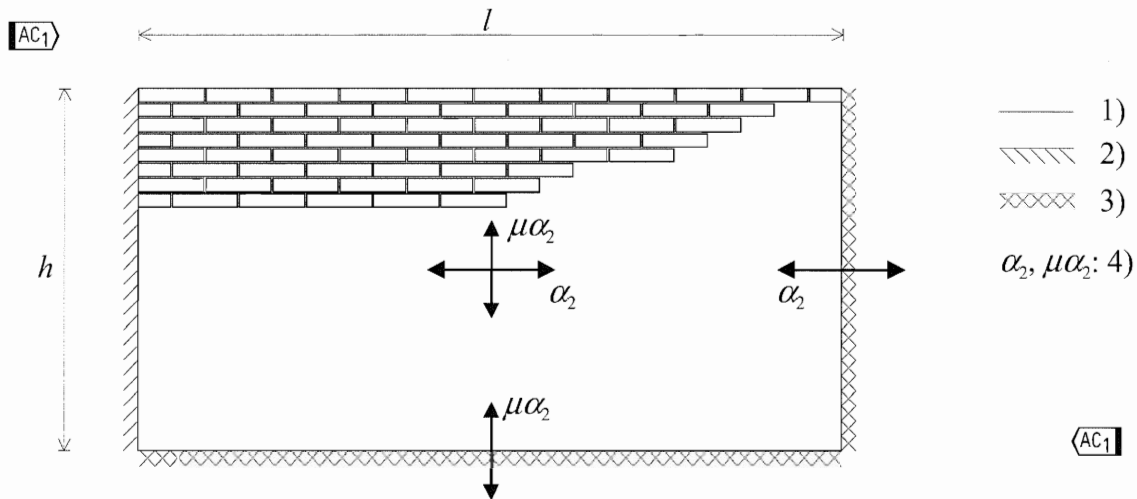

Figure D.2 — Graph showing values of ρ_4 using equations 5.8 and 5.9

Annex E
(informative)

Bending moment coefficients, α_2 , in single leaf laterally loaded wall panels of thickness less than or equal to 250 mm



Key

- 1) free edge
- 2) simply supported edge
- 3) fully restrained/continuous edge
- 4) moment coefficients in the indicated directions

Figure E.1 — Key to support conditions used in tables

Wall support condition

A

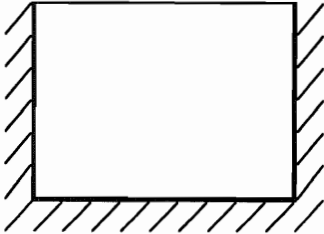

μ	h/l							
	0,30	0,50	0,75	1,00	1,25	1,50	1,75	2,00
1,00	0,031	0,045	0,059	0,071	0,079	0,085	0,090	0,094
0,90	0,032	0,047	0,061	0,073	0,081	0,087	0,092	0,095
0,80	0,034	0,049	0,064	0,075	0,083	0,089	0,093	0,097
0,70	0,035	0,051	0,066	0,077	0,085	0,091	0,095	0,098
0,60	0,038	0,053	0,069	0,080	0,088	0,093	0,097	0,100
0,50	0,040	0,056	0,073	0,083	0,090	0,095	0,099	0,102
0,40	0,043	0,061	0,077	0,087	0,093	0,098	0,101	0,104
0,35	0,045	0,064	0,080	0,089	0,095	0,100	0,103	0,105
0,30	0,048	0,067	0,082	0,091	0,097	0,101	0,104	0,107
0,25	0,050	0,071	0,085	0,094	0,099	0,103	0,106	0,109
0,20	0,054	0,075	0,089	0,097	0,102	0,105	0,108	0,111
0,15	0,060	0,080	0,093	0,100	0,104	0,108	0,110	0,113
0,10	0,069	0,087	0,098	0,104	0,108	0,111	0,113	0,115
0,05	0,082	0,097	0,105	0,110	0,113	0,115	0,116	0,117

Wall support condition

B

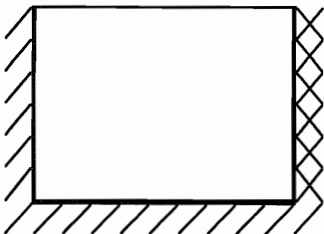

μ	h/l							
	0,30	0,50	0,75	1,00	1,25	1,50	1,75	2,00
1,00	0,024	0,035	0,046	0,053	0,059	0,062	0,065	0,068
0,90	0,025	0,036	0,047	0,055	0,060	0,063	0,066	0,068
0,80	0,027	0,037	0,049	0,056	0,061	0,065	0,067	0,069
0,70	0,028	0,039	0,051	0,058	0,062	0,066	0,068	0,070
0,60	0,030	0,042	0,053	0,059	0,064	0,067	0,069	0,071
0,50	0,031	0,044	0,055	0,061	0,066	0,069	0,071	0,072
0,40	0,034	0,047	0,057	0,063	0,067	0,070	0,072	0,074
0,35	0,035	0,049	0,059	0,065	0,068	0,071	0,073	0,074
0,30	0,037	0,051	0,061	0,066	0,070	0,072	0,074	0,075
0,25	0,039	0,053	0,062	0,068	0,071	0,073	0,075	0,077
0,20	0,043	0,056	0,065	0,069	0,072	0,074	0,076	0,078
0,15	0,047	0,059	0,067	0,071	0,074	0,076	0,077	0,079
0,10	0,052	0,063	0,070	0,074	0,076	0,078	0,079	0,080
0,05	0,060	0,069	0,074	0,077	0,079	0,080	0,081	0,082

Wall support condition

C

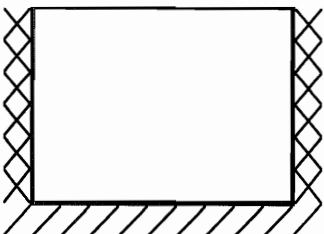

μ	h/l							
	0,30	0,50	0,75	1,00	1,25	1,50	1,75	2,00
1,00	0,020	0,028	0,037	0,042	0,045	0,048	0,050	0,051
0,90	0,021	0,029	0,038	0,043	0,046	0,048	0,050	0,052
0,80	0,022	0,031	0,039	0,043	0,047	0,049	0,051	0,052
0,70	0,023	0,032	0,040	0,044	0,048	0,050	0,051	0,053
0,60	0,024	0,034	0,041	0,046	0,049	0,051	0,052	0,053
0,50	0,025	0,035	0,043	0,047	0,050	0,052	0,053	0,054
0,40	0,027	0,038	0,044	0,048	0,051	0,053	0,054	0,055
0,35	0,029	0,039	0,045	0,049	0,052	0,053	0,054	0,055
0,30	0,030	0,040	0,046	0,050	0,052	0,054	0,055	0,056
0,25	0,032	0,042	0,048	0,051	0,053	0,054	0,056	0,057
0,20	0,034	0,043	0,049	0,052	0,054	0,055	0,056	0,058
0,15	0,037	0,046	0,051	0,053	0,055	0,056	0,057	0,059
0,10	0,041	0,048	0,053	0,055	0,056	0,057	0,058	0,059
0,05	0,046	0,052	0,055	0,057	0,058	0,059	0,059	0,060

Wall support condition

D

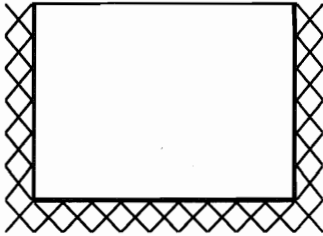

μ	h/l							
	0,30	0,50	0,75	1,00	1,25	1,50	1,75	2,00
1,00	0,013	0,021	0,029	0,035	0,040	0,043	0,045	0,047
0,90	0,014	0,022	0,031	0,036	0,040	0,043	0,046	0,048
0,80	0,015	0,023	0,032	0,038	0,041	0,044	0,047	0,048
0,70	0,016	0,025	0,033	0,039	0,043	0,045	0,047	0,049
0,60	0,017	0,026	0,035	0,040	0,044	0,046	0,048	0,050
0,50	0,018	0,028	0,037	0,042	0,045	0,048	0,050	0,051
0,40	0,020	0,031	0,039	0,043	0,047	0,049	0,051	0,052
0,35	0,022	0,032	0,040	0,044	0,048	0,050	0,051	0,053
0,30	0,023	0,034	0,041	0,046	0,049	0,051	0,052	0,053
0,25	0,025	0,035	0,043	0,047	0,050	0,052	0,053	0,054
0,20	0,027	0,038	0,044	0,048	0,051	0,053	0,054	0,055
0,15	0,030	0,040	0,046	0,050	0,052	0,054	0,055	0,056
0,10	0,034	0,043	0,049	0,052	0,054	0,055	0,056	0,057
0,05	0,041	0,048	0,053	0,055	0,056	0,057	0,058	0,059

Wall support condition

E

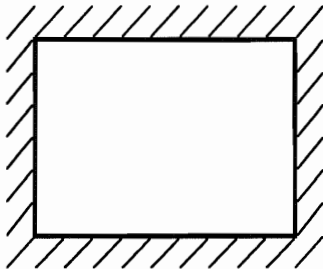

μ	h/l							
	0,30	0,50	0,75	1,00	1,25	1,50	1,75	2,00
1,00	0,008	0,018	0,030	0,042	0,051	0,059	0,066	0,071
0,90	0,009	0,019	0,032	0,044	0,054	0,062	0,068	0,074
0,80	0,010	0,021	0,035	0,046	0,056	0,064	0,071	0,076
0,70	0,011	0,023	0,037	0,049	0,059	0,067	0,073	0,078
0,60	0,012	0,025	0,040	0,053	0,062	0,070	0,076	0,081
0,50	0,014	0,028	0,044	0,057	0,066	0,074	0,080	0,085
0,40	0,017	0,032	0,049	0,062	0,071	0,078	0,084	0,088
0,35	0,018	0,035	0,052	0,064	0,074	0,081	0,086	0,090
0,30	0,020	0,038	0,055	0,068	0,077	0,083	0,089	0,093
0,25	0,023	0,042	0,059	0,071	0,080	0,087	0,091	0,096
0,20	0,026	0,046	0,064	0,076	0,084	0,090	0,095	0,099
0,15	0,032	0,053	0,070	0,081	0,089	0,094	0,098	0,103
0,10	0,039	0,062	0,078	0,088	0,095	0,100	0,103	0,106
0,05	0,054	0,076	0,090	0,098	0,103	0,107	0,109	0,110

Wall support condition

F

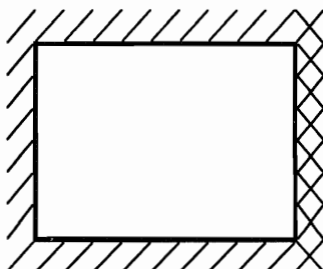

μ	h/l							
	0,30	0,50	0,75	1,00	1,25	1,50	1,75	2,00
1,00	0,008	0,016	0,026	0,034	0,041	0,046	0,051	0,054
0,90	0,008	0,017	0,027	0,036	0,042	0,048	0,052	0,055
0,80	0,009	0,018	0,029	0,037	0,044	0,049	0,054	0,057
0,70	0,010	0,020	0,031	0,039	0,046	0,051	0,055	0,058
0,60	0,011	0,022	0,033	0,042	0,048	0,053	0,057	0,060
0,50	0,013	0,024	0,036	0,044	0,051	0,056	0,059	0,062
0,40	0,015	0,027	0,039	0,048	0,054	0,058	0,062	0,064
0,35	0,016	0,029	0,041	0,050	0,055	0,060	0,063	0,066
0,30	0,018	0,031	0,044	0,052	0,057	0,062	0,065	0,067
0,25	0,020	0,034	0,046	0,054	0,060	0,063	0,066	0,069
0,20	0,023	0,037	0,049	0,057	0,062	0,066	0,068	0,070
0,15	0,027	0,042	0,053	0,060	0,065	0,068	0,070	0,072
0,10	0,032	0,048	0,058	0,064	0,068	0,071	0,073	0,074
0,05	0,043	0,057	0,066	0,070	0,073	0,075	0,077	0,078

Wall support condition

G

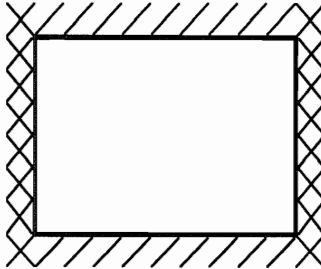

μ	h/l							
	0,30	0,50	0,75	1,00	1,25	1,50	1,75	2,00
1,00	0,007	0,014	0,022	0,028	0,033	0,037	0,040	0,042
0,90	0,008	0,015	0,023	0,029	0,034	0,038	0,041	0,043
0,80	0,008	0,016	0,024	0,031	0,035	0,039	0,042	0,044
0,70	0,009	0,017	0,026	0,032	0,037	0,040	0,043	0,045
0,60	0,010	0,019	0,028	0,034	0,038	0,042	0,044	0,046
0,50	0,011	0,021	0,030	0,036	0,040	0,043	0,046	0,048
0,40	0,013	0,023	0,032	0,038	0,042	0,045	0,047	0,049
0,35	0,014	0,025	0,033	0,039	0,043	0,046	0,048	0,050
0,30	0,016	0,026	0,035	0,041	0,044	0,047	0,049	0,051
0,25	0,018	0,028	0,037	0,042	0,046	0,048	0,050	0,052
0,20	0,020	0,031	0,039	0,044	0,047	0,050	0,052	0,054
0,15	0,023	0,034	0,042	0,046	0,049	0,051	0,053	0,055
0,10	0,027	0,038	0,045	0,049	0,052	0,053	0,055	0,057
0,05	0,035	0,044	0,050	0,053	0,055	0,056	0,057	0,058

Wall support condition

H

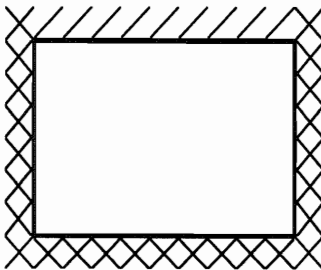

μ	h/l							
	0,30	0,50	0,75	1,00	1,25	1,50	1,75	2,00
1,00	0,005	0,011	0,018	0,024	0,029	0,033	0,036	0,039
0,90	0,006	0,012	0,019	0,025	0,030	0,034	0,037	0,040
0,80	0,006	0,013	0,020	0,027	0,032	0,035	0,038	0,041
0,70	0,007	0,014	0,022	0,028	0,033	0,037	0,040	0,042
0,60	0,008	0,015	0,024	0,030	0,035	0,038	0,041	0,043
0,50	0,009	0,017	0,025	0,032	0,036	0,040	0,043	0,045
0,40	0,010	0,019	0,028	0,034	0,039	0,042	0,045	0,047
0,35	0,011	0,021	0,029	0,036	0,040	0,043	0,046	0,047
0,30	0,013	0,022	0,031	0,037	0,041	0,044	0,047	0,049
0,25	0,014	0,024	0,033	0,039	0,043	0,046	0,048	0,051
0,20	0,016	0,027	0,035	0,041	0,045	0,047	0,049	0,052
0,15	0,019	0,030	0,038	0,043	0,047	0,049	0,051	0,053
0,10	0,023	0,034	0,042	0,047	0,050	0,052	0,053	0,054
0,05	0,031	0,041	0,047	0,051	0,053	0,055	0,056	0,056

Wall support condition

I

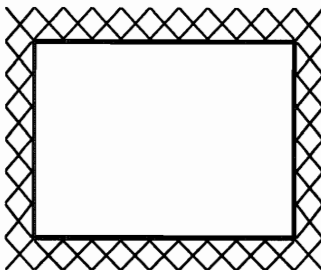

μ	h/l							
	0,30	0,50	0,75	1,00	1,25	1,50	1,75	2,00
1,00	0,004	0,009	0,015	0,021	0,026	0,030	0,033	0,036
0,90	0,004	0,010	0,016	0,022	0,027	0,031	0,034	0,037
0,80	0,005	0,010	0,017	0,023	0,028	0,032	0,035	0,038
0,70	0,005	0,011	0,019	0,025	0,030	0,033	0,037	0,039
0,60	0,006	0,013	0,020	0,026	0,031	0,035	0,038	0,041
0,50	0,007	0,014	0,022	0,028	0,033	0,037	0,040	0,042
0,40	0,008	0,016	0,024	0,031	0,035	0,039	0,042	0,044
0,35	0,009	0,017	0,026	0,032	0,037	0,040	0,043	0,045
0,30	0,010	0,019	0,028	0,034	0,038	0,042	0,044	0,046
0,25	0,011	0,021	0,030	0,036	0,040	0,043	0,046	0,048
0,20	0,013	0,023	0,032	0,038	0,042	0,045	0,047	0,050
0,15	0,016	0,026	0,035	0,041	0,044	0,047	0,049	0,051
0,10	0,020	0,031	0,039	0,044	0,047	0,050	0,052	0,054
0,05	0,027	0,038	0,045	0,049	0,052	0,053	0,055	0,056

Wall support condition

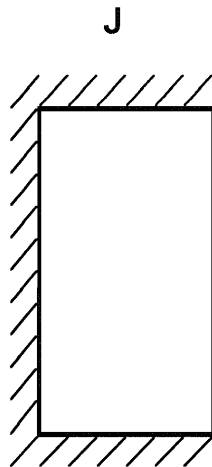

μ	h/l							
	0,30	0,50	0,75	1,00	1,25	1,50	1,75	2,00
1,00	0,009	0,023	0,046	0,071	0,096	0,122	0,151	0,180
0,90	0,010	0,026	0,050	0,076	0,103	0,131	0,162	0,193
0,80	0,012	0,028	0,054	0,083	0,111	0,142	0,175	0,208
0,70	0,013	0,032	0,060	0,091	0,121	0,156	0,191	0,227
0,60	0,015	0,036	0,067	0,100	0,135	0,173	0,211	0,250
0,50	0,018	0,042	0,077	0,113	0,153	0,195	0,237	0,280
0,40	0,021	0,050	0,090	0,131	0,177	0,225	0,272	0,321
0,35	0,024	0,055	0,098	0,144	0,194	0,244	0,296	0,347
0,30	0,027	0,062	0,108	0,160	0,214	0,269	0,325	0,381
0,25	0,032	0,071	0,122	0,180	0,240	0,300	0,362	0,428
0,20	0,038	0,083	0,142	0,208	0,276	0,344	0,413	0,488
0,15	0,048	0,100	0,173	0,250	0,329	0,408	0,488	0,570
0,10	0,065	0,131	0,224	0,321	0,418	0,515	0,613	0,698
0,05	0,106	0,208	0,344	0,482	0,620	0,759	0,898	0,959

Wall support condition

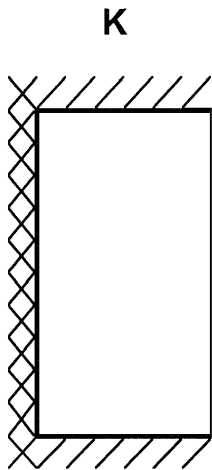

μ	h/l							
	0,30	0,50	0,75	1,00	1,25	1,50	1,75	2,00
1,00	0,009	0,021	0,038	0,056	0,074	0,091	0,108	0,123
0,90	0,010	0,023	0,041	0,060	0,079	0,097	0,113	0,129
0,80	0,011	0,025	0,045	0,065	0,084	0,103	0,120	0,136
0,70	0,012	0,028	0,049	0,070	0,091	0,110	0,128	0,145
0,60	0,014	0,031	0,054	0,077	0,099	0,119	0,138	0,155
0,50	0,016	0,035	0,061	0,085	0,109	0,130	0,149	0,167
0,40	0,019	0,041	0,069	0,097	0,121	0,144	0,164	0,182
0,35	0,021	0,045	0,075	0,104	0,129	0,152	0,173	0,191
0,30	0,024	0,050	0,082	0,112	0,139	0,162	0,183	0,202
0,25	0,028	0,056	0,091	0,123	0,150	0,174	0,196	0,217
0,20	0,033	0,064	0,103	0,136	0,165	0,190	0,211	0,234
0,15	0,040	0,077	0,119	0,155	0,184	0,210	0,231	0,253
0,10	0,053	0,096	0,144	0,182	0,213	0,238	0,260	0,279
0,05	0,080	0,136	0,190	0,230	0,260	0,286	0,306	0,317

Wall support condition

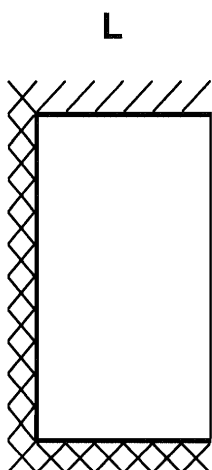

μ	h/l							
	0,30	0,50	0,75	1,00	1,25	1,50	1,75	2,00
1,00	0,006	0,015	0,029	0,044	0,059	0,073	0,088	0,102
0,90	0,007	0,017	0,032	0,047	0,063	0,078	0,093	0,107
0,80	0,008	0,018	0,034	0,051	0,067	0,084	0,099	0,114
0,70	0,009	0,021	0,038	0,056	0,073	0,090	0,106	0,122
0,60	0,010	0,023	0,042	0,061	0,080	0,098	0,115	0,131
0,50	0,012	0,027	0,048	0,068	0,089	0,108	0,126	0,142
0,40	0,014	0,032	0,055	0,078	0,100	0,121	0,139	0,157
0,35	0,016	0,035	0,060	0,084	0,108	0,129	0,148	0,165
0,30	0,018	0,039	0,066	0,092	0,116	0,138	0,158	0,176
0,25	0,021	0,044	0,073	0,101	0,127	0,150	0,170	0,190
0,20	0,025	0,052	0,084	0,114	0,141	0,165	0,185	0,206
0,15	0,031	0,061	0,098	0,131	0,159	0,184	0,205	0,226
0,10	0,041	0,078	0,121	0,156	0,186	0,212	0,233	0,252
0,05	0,064	0,114	0,164	0,204	0,235	0,260	0,281	0,292

Annex F (informative)

Limiting height and length to thickness ratios for walls under the serviceability limit state

(1) Notwithstanding the ability of a wall to satisfy the ultimate limit state, which must be verified, its size should be limited to that which results from use of figures F.1, F.2 or F.3, depending on the restraint conditions as shown on the figures, where h is the clear height of the wall, l is the length of the wall and t is the thickness of the wall; for cavity walls use t_{ef} in place of t .

(2) Where walls are restrained at the top but not at the ends, h should be limited to $30 t$.

(3) This annex is valid when the thickness of the wall, or one leaf of a cavity wall, is not less than 100 mm.

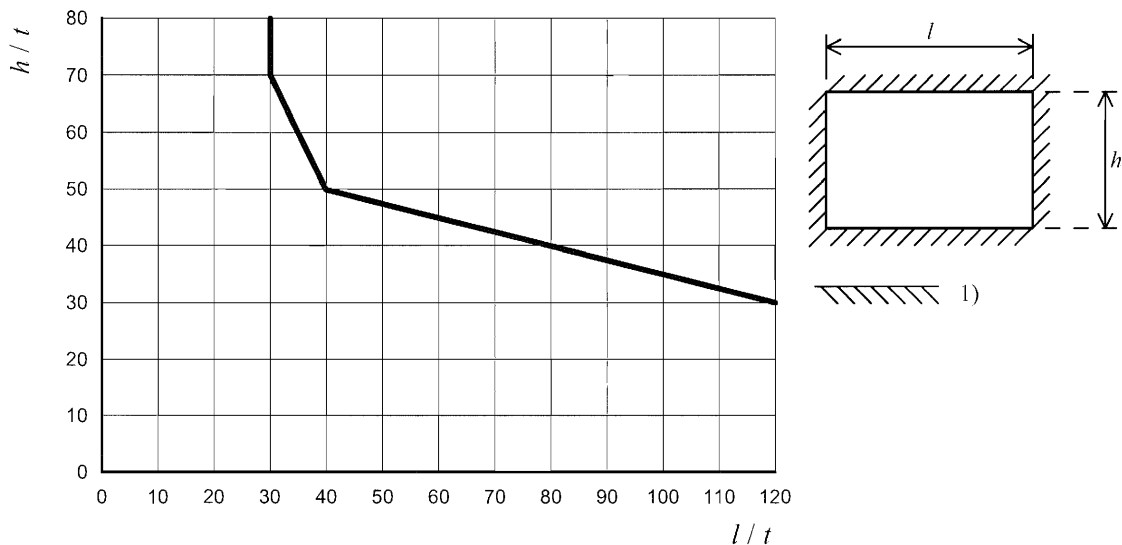

Key

1) simply supported or with full continuity

**Figure F.1 — Limiting height and length to thickness ratios
of walls restrained on all four edges**

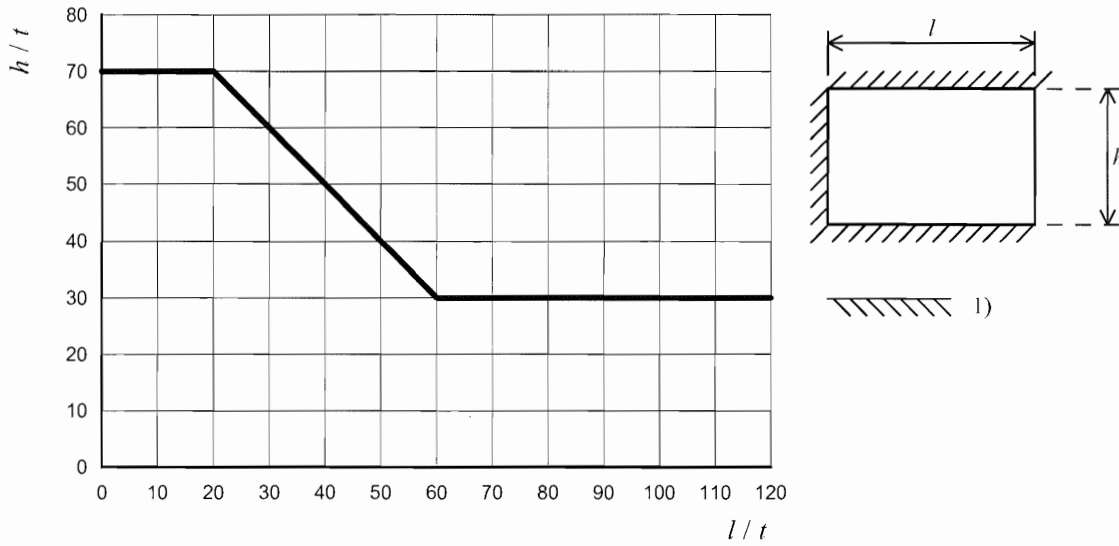

Key

- 1) simply supported or with full continuity

Figure F.2 — Limiting height and length to thickness ratios of walls restrained at the bottom, the top and one vertical edge

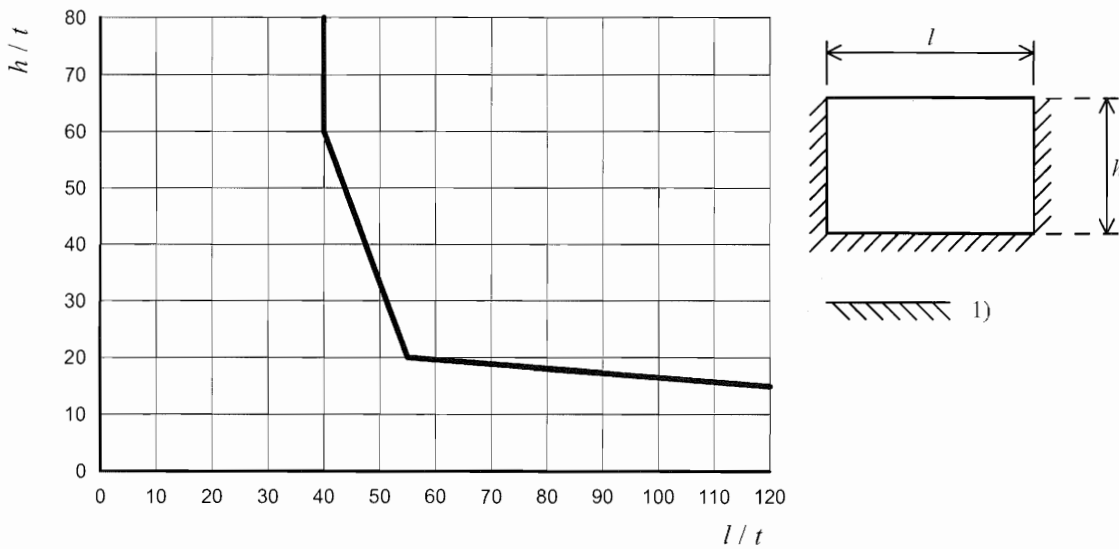

Key

- 1) simply supported or with full continuity

Figure F.3 — Limiting height and length to thickness ratios of walls restrained at the edges, the bottom, but not the top

Annex G (informative)

Reduction factor for slenderness and eccentricity

(1) In the middle of the wall height, by using a simplification of the general principles given in 6.1.1, the reduction factor, Φ_m , taking into account the slenderness of the wall and the eccentricity of loading, for any modulus of elasticity E and characteristic compressive strength of unreinforced masonry f_k , may be estimated from:

$$\boxed{\text{AC1}} \Phi_m = A_1 e^{-\frac{u^2}{2}} \quad (\text{G.1}) \quad \boxed{\text{AC1}}$$

where:

$$A_1 = 1 - 2 \frac{e_{mk}}{t} \quad (\text{G.2})$$

$$u = \frac{\lambda - 0,063}{0,73 - 1,17 \frac{e_{mk}}{t}} \quad (\text{G.3})$$

where:

$$\lambda = \frac{h_{ef}}{t_{ef}} \sqrt{\frac{f_k}{E}} \quad (\text{G.4})$$

and e_{mk} , h_{ef} , t and t_{ef} are as defined in 6.1.2.2, and e is the base of natural logarithms.

(2) For $E = 1\,000 f_k$ equations (G.3) becomes:

$$u = \frac{\frac{h_{ef}}{t_{ef}} - 2}{23 - 37 \frac{e_{mk}}{t}} \quad (\text{G.5})$$

and for $E = 700 f_k$:

$$u = \frac{\frac{h_{ef}}{t_{ef}} - 1,67}{19,3 - 31 \frac{e_{mk}}{t}} \quad (\text{G.6})$$

(3) The values of Φ_m derived from equation (G.5) and (G.6) are represented in graphical form in figure G.1 and G.2

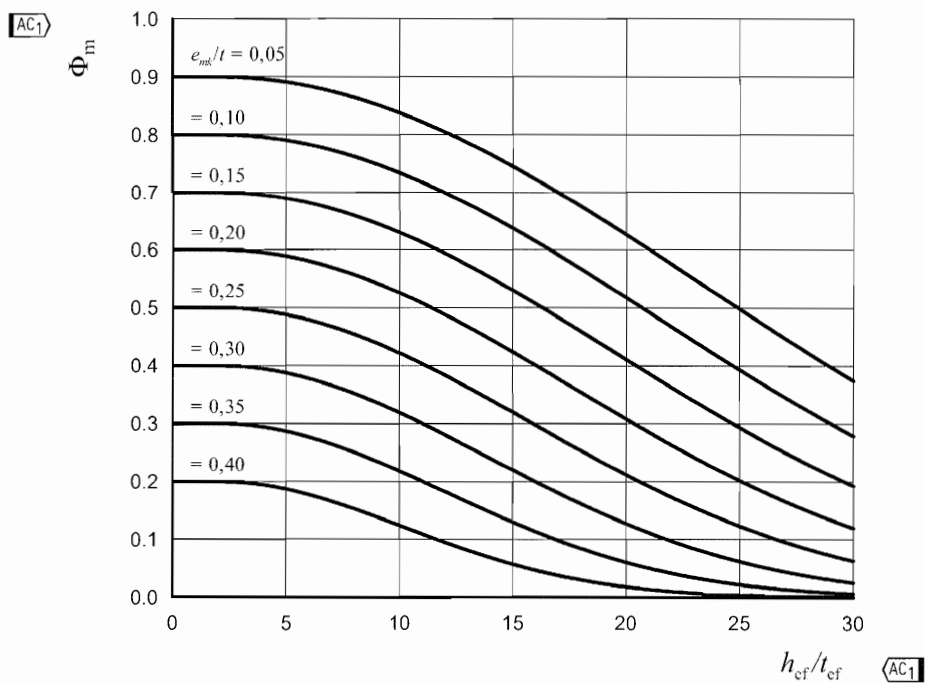

Figure G.1 — Values of Φ_m against slenderness ratio for different eccentricities, based on an E of $1000 f_k$

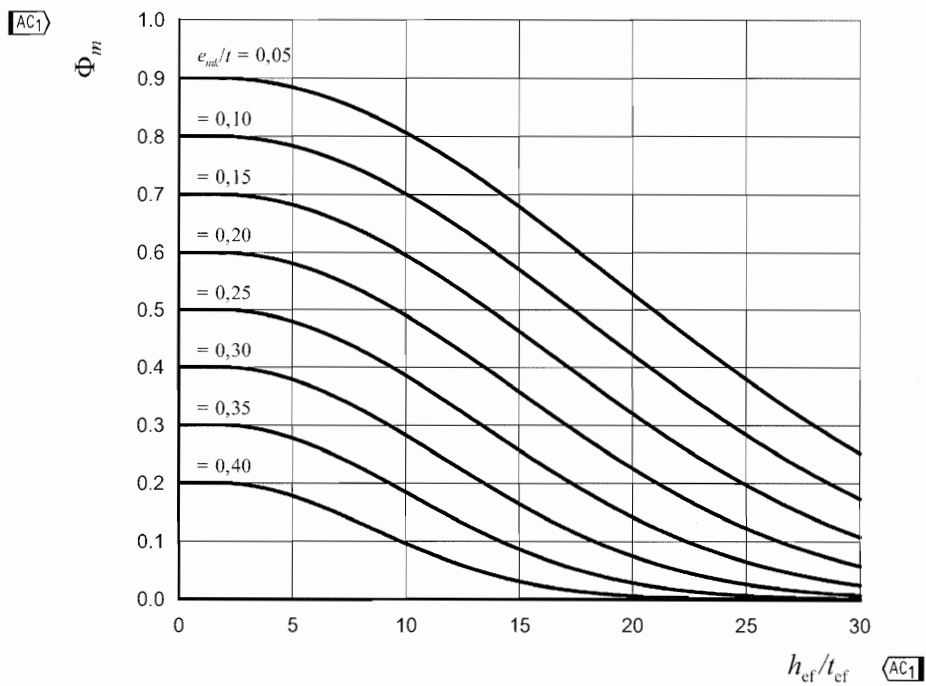

Figure G.2 — Values of Φ_m against slenderness ratio for different eccentricities, based on an E of $700 f_k$

Annex H (informative)

Enhancement factor as given in 6.1.3

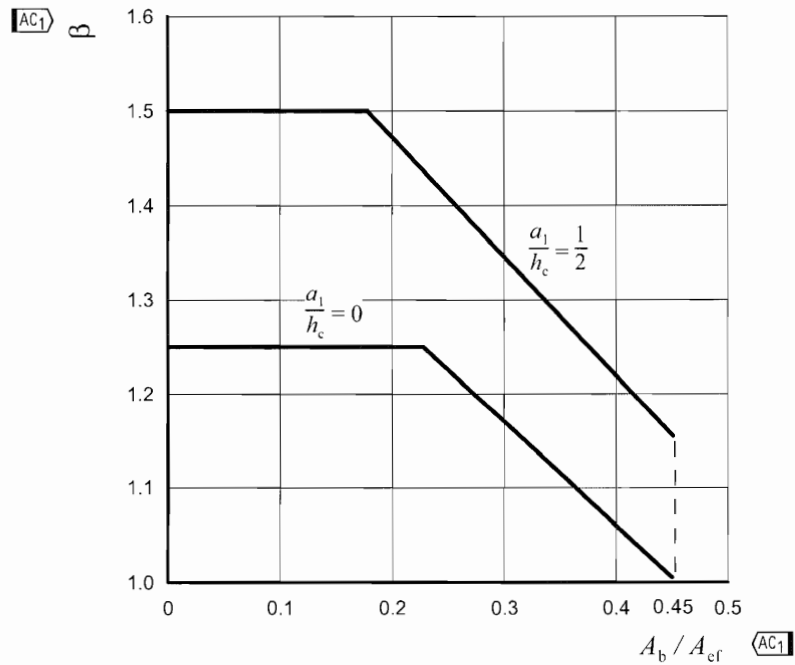

Figure H.1 — Graph showing the enhancement factor as given in 6.1.3:
Concentrated loads under bearings

Annex I (informative)

Adjustment of lateral load for walls supported on three or four edges subjected to out-of-plane horizontal loading and vertical loading

(1) The wall is assumed to be subject to a horizontal out-of-plane load, and an eccentric vertical load.

NOTE It may be possible to redistribute the moment at the top of the wall (caused by the eccentricity of the vertical load) over the inner and outer leaves of a cavity wall if adequate ties are specified in the design for this purpose.

(2) If the wall is a part of a cavity wall, the horizontal out-of-plane load may be divided between the two leaves (see 6.3.1(6)).

(3) The vertical load above openings should be distributed over the walls at the sides of the openings.

(4) The horizontal out-of-plane load acting on the wall for use in the verification according to clause 6.1, may be reduced by a factor k using expression I.1

$$k = 8 \mu \alpha \frac{l^2}{h^2} \quad (\text{I.1})$$

NOTE The factor k expresses the ratio between the load capacity of a vertically spanning wall and the lateral load capacity of the actual wall area (taking possible edge restraints into account).

where:

k is the lateral load capacity of a vertically spanning wall divided by the lateral load capacity of the actual wall area (taking edge restraint into account)

α is the relevant bending moment coefficient in accordance with 5.5.5;

μ is the orthogonal ratio of characteristic flexural strengths of the masonry in accordance with 5.5.5;

h is the height of the wall;

l is the length of the wall.

Annex J (informative)

Reinforced masonry members subjected to shear loading: enhancement of f_{vd}

(1) In the case of walls or beams where the main reinforcement is placed in pockets, cores or cavities filled with concrete infill as described in 3.3, the value of f_{vd} used to calculate V_{RDI} may be obtained from the following equation:

$$f_{vd} = \frac{(0,35 + 17,5 \rho)}{\gamma_M} \quad (J.1)$$

provided that f_{vd} is not taken to be greater than $\frac{0,7}{\gamma_M}$ N/mm²,

where:

$$\rho = \frac{A_s}{b d} \quad (J.2)$$

A_s is the cross sectional area of the primary reinforcement;

b is the width of the section;

d is the effective depth;

γ_M is the partial factor for masonry .

(2) For simply supported reinforced beams or cantilever retaining walls where the ratio of the shear span, a_v , to the effective depth, d , is six or less, f_{vd} may be increased by a factor, χ , where:

$$\chi = \left[2,5 - 0,25 \frac{a_v}{d} \right] \quad (J.3)$$

provided that f_{vd} is not taken to be greater than $1,75/\gamma_M$ N/mm².

The shear span, a_v , is taken to be the maximum bending moment in the section divided by the maximum shear force in the section.